

LOAD RESTRAINT GUIDELINE

Tube bundles CHS, RHS and mixed loads

1. This guideline applies to:

- Circular and square / rectangular hollow section tubes (coated and/or uncoated) bundled into **regular hexagonal or square / rectangular packs**. *Note: this guideline does not apply to irregular packs or elliptical tubes.*

The lowest friction factor for this product determined as per EN 12195-1:2010 Annex B.1.2, is $\mu=0.29$ (for 'oiled' tubes).

2. Equipment requirements

- Trailer headboards** must be a minimum of 1.5 m high and cover the entire load to prevent individual bars spearing out of the bundles. **NEVER load any part of the load above the trailer headboard.**
- Side pins** must cover up to at least the mid-point of the top bundle with at least 2 pairs of side pins covering each length of tube bundle.
- Timbers** must be square cross-section. Full-width timbers must be a minimum of 75 mm square. Shorter packing timbers (e.g. 60 mm, 75 mm or 100 mm square) should be used as shown in Section 7.
- Restraint straps** must be web lashings compliant with EN 12195-2 with a lashing capacity of 2000 daN min.
- Edge protection** should be used on straps fitted close to sharp edges e.g. steel banding on tube bundles.

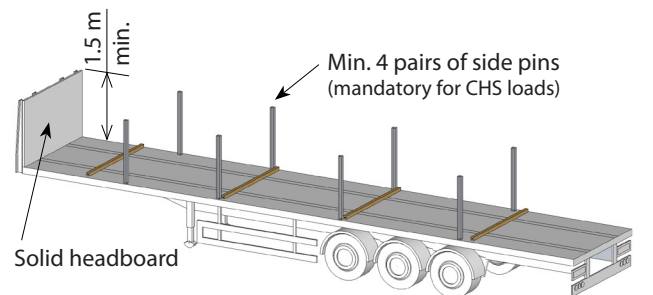

Dunnage: Square base timbers should be supplied by haulier; packers supplied by Tata Steel.

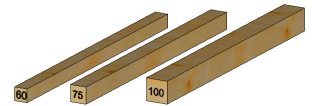

Up to 14 straps are required:
6 off 8 m long (for opposing loops)
8 off 6 m long



Edge protection: as required.



3. Load build options and securing methods

Loads must be built and secured as either:

- 'Layered' loads or
- 'Pyramid' loads as shown below and secured accordingly as shown in Sections 4 and 5 overleaf.

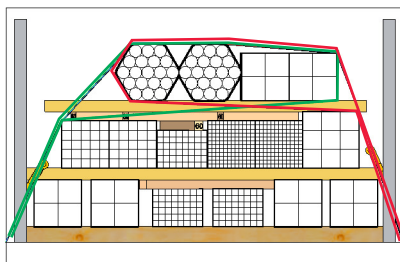

Top layer
Full width timbers
Middle layer(s)
Full width timbers
Base layer
Full width timbers

'Layered' load - secured with over-the-top straps and 3 pairs of opposing loop straps around the top layer

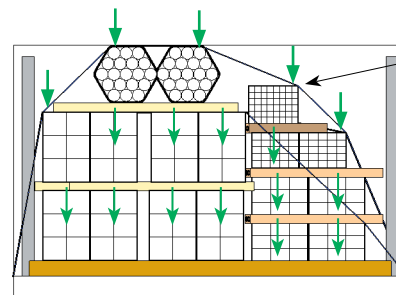

Straps must deflect over bundles to give effective clamping

'Pyramid' load - secured with over-the-top straps clamping down every tube bundle in the load

This Load Restraint Guideline has been designed to meet the forces for road transport, intermodal rail and sea area B crossings as stated in EN 12195-1:2010 and VDI 2700 with the load either blocked to the trailer headboard or loaded away from the headboard.

LOAD RESTRAINT GUIDELINE

Tube bundles CHS, RHS and mixed loads

4. Layered load

- Whenever possible build the load in discrete layers using packing timbers to provide level tiers (see Section 7).
- Apply horizontal timbers across the full width of the load in each layer to create a stable, solid pack allowing opposing loop straps to be fitted.
- Top layers with more than 2 bundles must be secured with 3 pairs of opposing loop straps as shown below.

Table 1: General strapping requirements

Load weight	Opposing loops	Over-the-top straps	Total straps
Up to 20 tonnes	3 pairs	4	10
20 - 24 tonnes	3 pairs	6	12
Over 24 tonnes	3 pairs	8	14

Example load over 24 tonnes

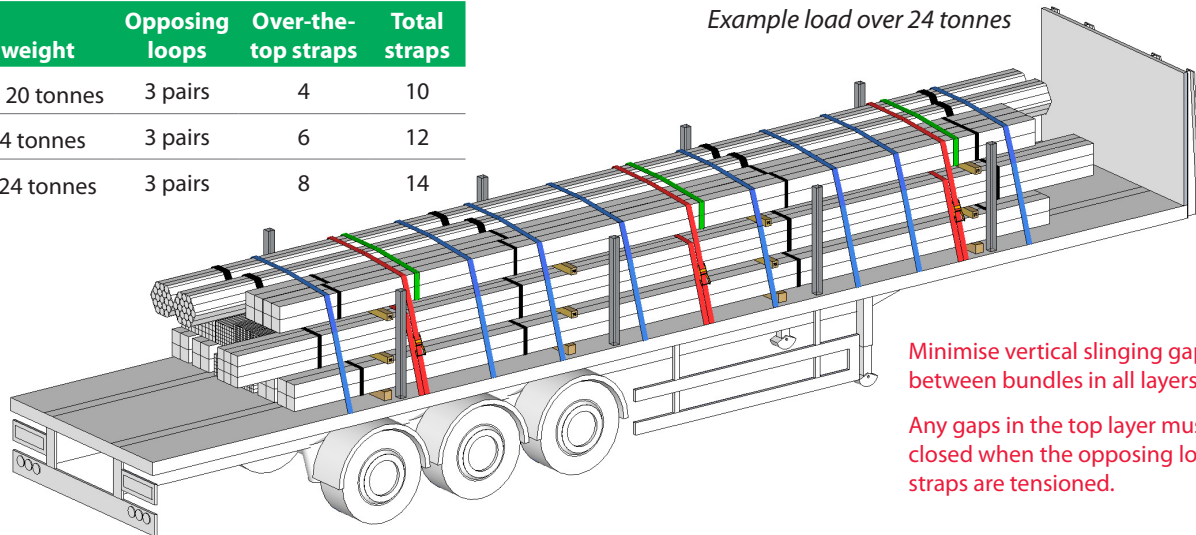

Minimise vertical slinging gaps between bundles in all layers.

Any gaps in the top layer must be closed when the opposing loop straps are tensioned.

Opposing loop straps are applied in the following way to the top layer with more than 2 bundles:

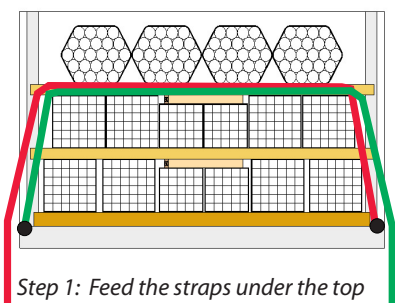

Step 1: Feed the straps under the top layer or position the straps on the load in pairs before the top layer is loaded.

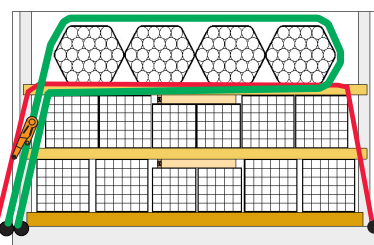

Step 2: Throw the free ends of the straps back over the load and apply a tensioner. Note the same anchor point may be used for the tensioner and the strap hook.

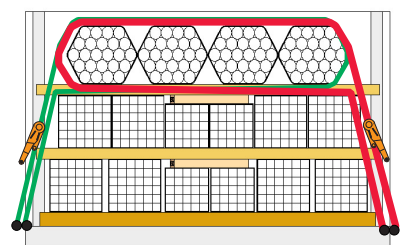

Step 3: Repeat step 2 for the 2nd strap of the opposing loop pair. Tension BOTH straps of each pair to pull to top layer of tube bundles together.

5. Pyramid load (when opposing loops cannot be fitted to the top layer)

- Maximum of 2 bundles in the uppermost row - no gap.
- All bundles must be clamped down by the straps or by the timbers in the load build.

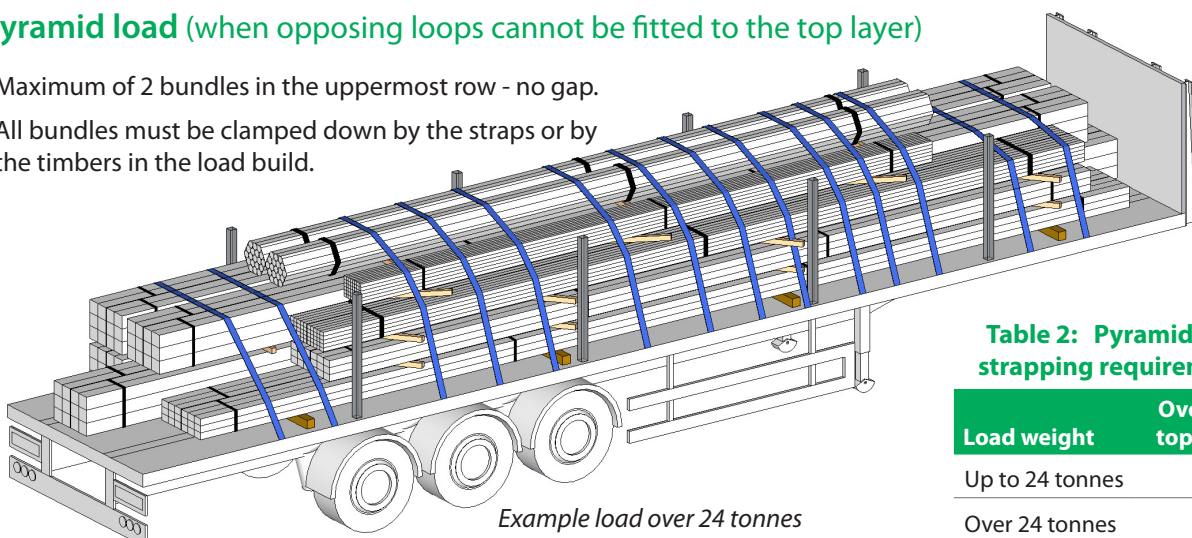

Example load over 24 tonnes

Table 2: Pyramid load strapping requirements

Load weight	Over-the-top straps
Up to 24 tonnes	12
Over 24 tonnes	14

LOAD RESTRAINT GUIDELINE

Tube bundles CHS, RHS and mixed loads

6. General load build rules

6.1 Load height - headboard and side pins

- ✓ All tubes must be below the top of the solid part of the trailer in case a tube spears out of the pack under emergency braking etc.
- ✓ Side pins must cover at least the mid-point of the top bundle.

6.2 Load width

- ✓ Maximum planned load width is 2286 mm to fit inside side pins.

6.3 Small bundles in centre

- ✓ Pack smaller bundles in between larger sized bundles.

6.4 Minimize gaps between bundles in lower layers and always close gaps in top layer

6.5 Use packing timbers to ensure every tube bundle is clamped down throughout the load

6.6 Loading to headboard

- ✓ When loading to the headboard the gaps should be minimized.
- ✓ Headboard should be XL-rated to EN 12642 **or equivalent**.

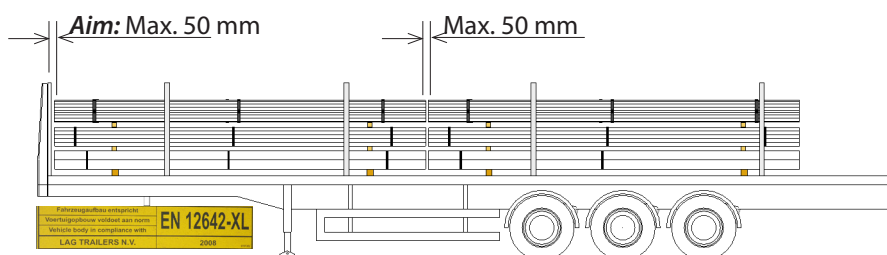

6.7 Loading from headboard

- ✓ When loading away from the headboard the gap should be at least 300 mm to allow the straps to tension up fully in the event of emergency braking.

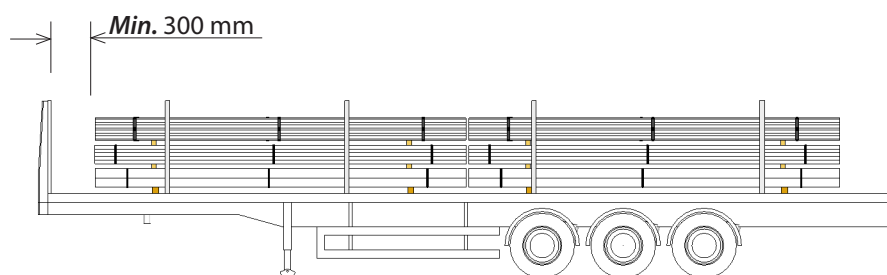

6.8 Overhangs

- ✓ Maximum overhang of long bundles on shorter bundles is 1 m front and rear.
- ✗ Do not strap on overhanging part of the bundles.

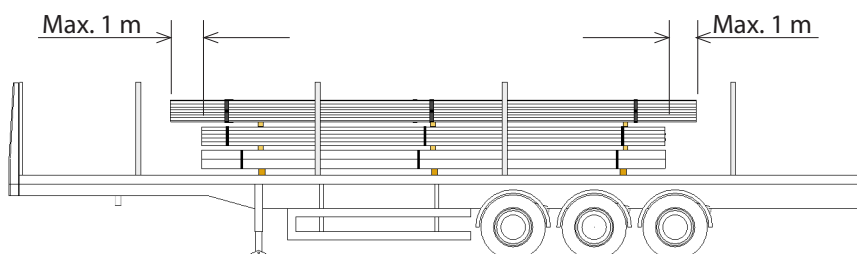

6.9 Axle weights

- ✓ Position the load forward/rearwards on the trailer to ensure compliance with axle weight limits for the countries through which the load will travel. Refer to TIS-0012 *Axle weights and load distribution* for more guidance.

LOAD RESTRAINT GUIDELINE

Tube bundles CHS, RHS and mixed loads

7. Timber dunnage

All bundles within the load must be adequately clamped down by the straps. This should be achieved by applying timber dunnage during the load build to pack out differences in heights between adjacent tube bundles.

- ✓ Whenever possible, use full-width timbers between tiers to create a stable load
- ✓ Lay packing timbers at 45°
- ✓ Ensure sufficient packers are used to support the weight of steel above
- ✓ Max. 2 layers of packing timbers at 45° to each other below the full width timber

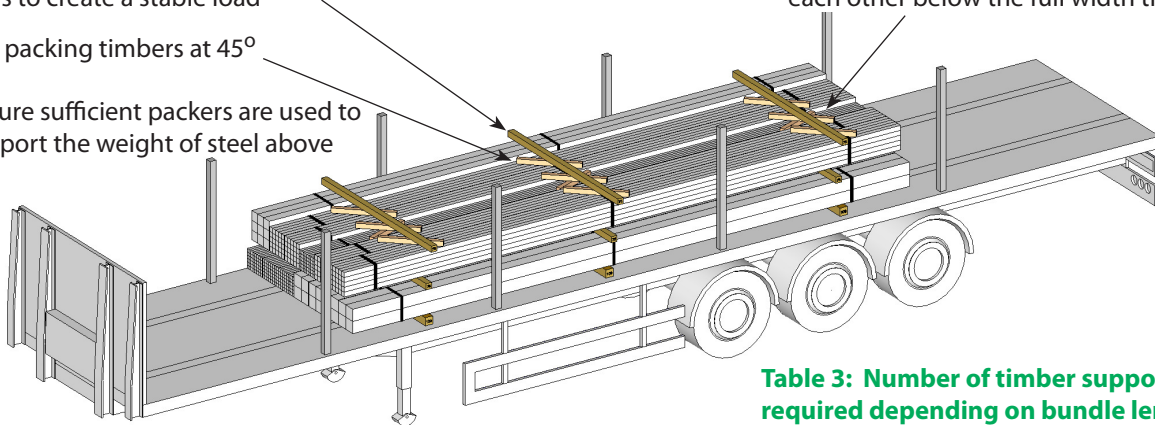

- ✗ NEVER double stack timbers in-line with each other; and
- ✗ NEVER stack timbers '1-on-2' due to the risk of toppling off:

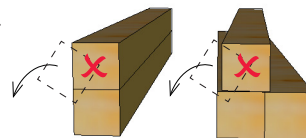

Table 3: Number of timber supports required depending on bundle length

Bundle length	No. of timber supports
Up to & incl. 6 m	2
Above 6 m up to 9 m	3
Above 9 m	4

8. Controlling vertical gaps in the load

All gaps in the **top tier** of the load must be either closed up or blocked securely. Small gaps (up to 100 mm) are allowed in the lower tiers.

Note: the combined weight of the product above and the clamping of the restraint straps will prevent the lower tier bundles from moving sideways.

For more information refer to Technical Information Sheet TIS-0007 *Controlling gaps in loads*.

- ✓ To accommodate customers' off-loading requirements bundles can be staggered:

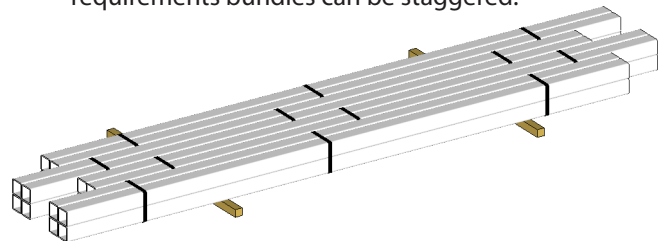

9. Intermodal rail loads

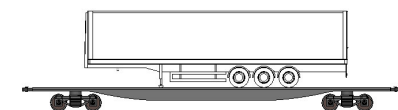

- Dry product can be moved with the restraints listed in Tables 1 or 2.
- Oiled tubes (i.e. rust veto coated) require additional over-the-top straps as listed in the Table 4.

Table 4: Lashing requirements for intermodal rail loads of oiled tubes

Load weight	Opposing loops	Over-the-top straps	Total straps required
Up to 20 tonnes	3 pairs	5	11
20 - 24 tonnes	3 pairs	8	14
Above 24 tonnes	3 pairs	10	16

10. Freezing conditions

- Trailer beds must be cleared of snow, ice and frost.
- Timbers must be dry and free from frost and ice.
- NEVER load on frozen timbers.
- Anti-slip matting can be used on both sides of timbers to increase friction within the load if there is a risk of frost forming in the load.



Care has been taken to ensure that the contents of this publication are accurate, but Tata Steel Europe Limited and its subsidiaries do not accept responsibility or liability for errors or information that is found to be misleading.