

TATA STEEL



Trisobuild®

Site assembled roofing and cladding systems



Contents

- 4-5 Introduction and benefits
- 6-9 Profile types
- 10 Trisobuild® systems reference guide
- 11 Trisobuild® R /RWL systems
- 12-13 Trisobuild® CR system
- 14-17 Trisobuild® acoustic systems
- 18 Trisobuild® wall systems
- 19 Trisobuild® - Fire performance
- 20-21 Trisobuild® fire wall systems
- 22 Trinsul® system
- 23 Colorcoat® products and services
- 24-25 Quality assurance and site guidance
- 26-34 Roof construction details and installation guidance
- 35-46 Wall construction details and installation guidance
- 47 Performance benefits



Tata Steel

Tata Steel is one of Europe's leading steel producers. Our comprehensive range of high quality products and services are supported by steel making sites in the UK and The Netherlands, a European-wide distribution and service centre network and downstream businesses ranging from tubes and building systems to plating.

Our approach to business is unique. We believe our strength is how we build collaborative relationships that create new success for our customers, adding value to their business and helping them to perform in their markets. As a company, we are dedicated to managing our operations responsibly and to continuously improving our performance. We operate in a way that is safe for our people and which respects the environment, with care towards the communities surrounding our operations and beyond.

Sustainability

Steel is an essential material, intrinsic to our way of life and to the products society will demand in a sustainable future. Steel is a material that is used, not consumed. It is recycled and used again, without any loss of quality, time after time. At Tata Steel, we are committed to making the products society

needs and to making them in the most responsible way possible.

This means, practically, that we commit to:

- Producing steel products for the future.
- Investing in sustainable steel making.
- Improving our existing processes.
- Facilitating the recycling loop.

Building envelope

Tata Steel has extensive panel and profiling manufacturing capabilities. We are the only company able to offer a comprehensive range of insulated panels, built-up systems, special profiles, structural roof and floor decking profiles from one single UK source, with the support and backing of a truly global company and complete supply chain.

With such a diverse product portfolio and 60 years experience, we are uniquely able to offer the specifier an unbiased solution to meet the design criteria for any project.

London Victoria Station

Client: Network Rail

Main contractor: May Gurney

Design engineer: WSP

Tata Steel products: Trisobuild® R46 and PM13 profiles

Colorcoat® product: Colorcoat HPS200 Ultra®

Trisobuild®

Made in the UK at our Shotton site in North Wales, Tata Steel offers a comprehensive range of Trisobuild® systems tailored to meet the requirements of your building specification. Our internal and external profiles offer design flexibility with an offering from 19mm to 46mm deep and a choice of perforated liners for acoustic applications.

Trisobuild® systems can be customised to meet your design requirements including thermal performance, fire resistance and acoustic performance. All our Trisobuild® systems comprise of a Colorcoat® pre-finished steel trapezoidal liner profile, an Instaloc® Plus spacer system, an insulation layer and a Colorcoat® pre-finished steel external weathering profile.

Technical support freely available

All our products are fully tested by third parties for criteria such as thermal performance, fire safety, acoustic performance, air-tightness, and resistance to water penetration. This together with our extensive and unbiased technical support sets us apart.

We will recommend the most appropriate system for your project to provide you with a building envelope solution that meets your requirements, performance criteria and is long lasting.

We offer support on:

- Specification writing.
- Detail design.
- Wind and snow load calculations.
- U-value calculation.
- Load span checks.
- Acoustic SRI predictions.
- Building Regulations advice.
- Assistance with SBEM.
- Advice on maximising BREEAM credits.
- Condensation risk analysis.
- Fire performance.

Trisobuild® systems

- ① Colorcoat® pre-finished steel external weathering profile.
- ② Platinum® Plus approved insulation layer.
- ③ Instaloc® Plus spacer system.
- ④ Colorcoat® pre-finished steel liner profile.

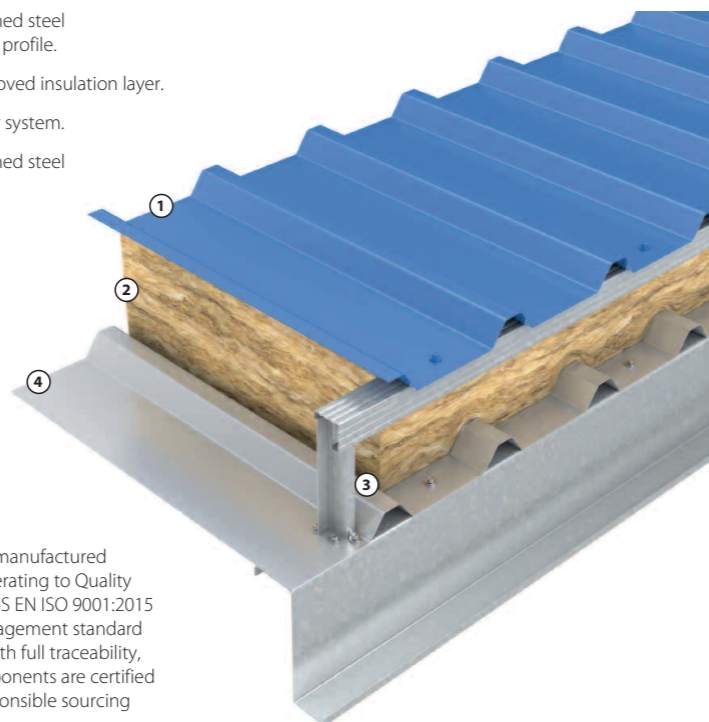

All our steel profiles are manufactured in factory conditions operating to Quality Management standard BS EN ISO 9001:2015 and Environmental Management standard BS EN ISO 14001:2015 with full traceability, all our steel profile components are certified 'Very Good' to BRE's responsible sourcing standard BES 6001.

Instaloc® Plus

The Instaloc® Plus spacer system from Tata Steel provides a stronger design than a conventional spacer.

This design is incorporated into both Trisobuild® roof and vertical wall systems and provides a stable platform with depths available from 140mm up to 400mm in 20mm increments.

This increased strength allows the designer the ability to specify deeper systems to comply with the demands of lower U-value requirements.

Comprehensive testing has shown that the bracket spacing can extend to 1200mm in most load cases, saving time and material cost as well as complementing standard insulation quilt widths

For further information on span load and installation details please contact our Technical Department on +44 (0) 1244 892199.

All U-value calculations shown within this brochure for roof and vertical wall systems incorporate the Instaloc® Plus spacer.



Platinum® Plus system guarantee

A guarantee of enduring performance

Platinum® Plus is a system guarantee for up to 30 years, that covers the durability, structural and thermal performance of all system components. It is fully transferable on change of ownership of the building. Our reputable supply chain partners and commitment to responsible sourcing creates an enhanced building envelope system that is robust and proven. Platinum® Plus offers enduring durability and building performance, lowering cost of ownership through the life of the building.

Key features of Platinum® Plus system guarantee:

- Support from specification to on-site check.
- One point of contact.
- Broad choice of components available directly from leading suppliers.
- 60 years' experience and extensive testing.
- Fully traceable and integrated Tata Steel supply chain.
- Underpinned by Confidex®.
- EPD third-party verification.
- Fully transferable guarantee direct to the building owner.

Create online project specific specifications:

Generate bespoke building envelope systems that will bring your design to life. Our online specification builder is super easy to use, complete with 3D product previews and access to our full range of colours. Manage all your specifications from 'My projects'.

For information and help on creating your Platinum® Plus tailored specification please contact:

T: +44 (0) 1244 892199
E: technical.envelopeproducts@tatasteel.com
www.tatasteelconstruction.com/speccreator



Roof profiles

Tata Steel offer an attractive range of roof profiles to meet both the aesthetic and structural requirements of the designer.

Load/span figures

The load/span information in the table below is based on safe loads over a 1.8m span and a deflection limit of L/200 and should be used as a guide only. For full load span table information please visit our website or contact the Technical Department on +44 (0) 1244 892199.

Curving

Although the self curve minimum values shown have been chosen with aesthetics in mind some stress marking may be present in the profile trough. The factory curved data relates to a single convex curve. Information regarding double or wave curves please contact the Technical Department.

Further information about design and detailing of a curved roof can be found under the Trisobuild® CR system section of this brochure.

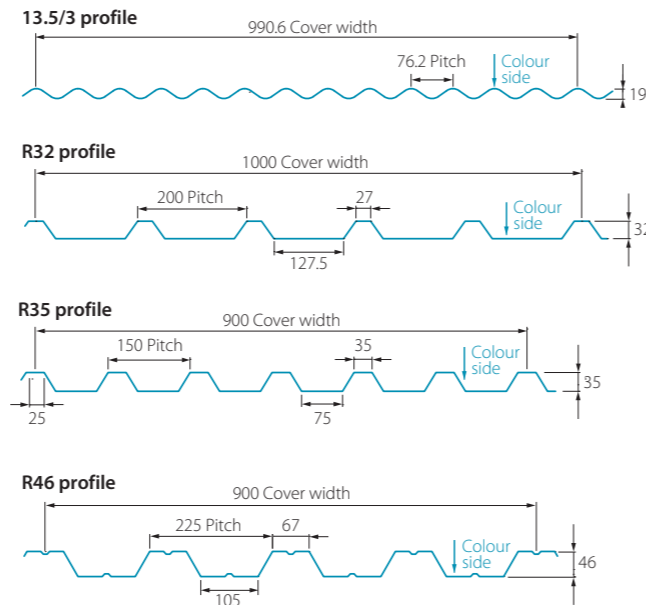

Note: all measurements in diagrams are in mm.

Roof profile range

Profile	Material and available finish	Gauge (mm)	Weight (kg/m ²)	Max. load for a 1.8m span						Max. sheet length	Min. convex self curve (m)	Min. factory curve (mm)*	Min. roof pitch***
				Imposed load (kN/m ²)			Wind suction load (kN/m ²)						
				Single span	Double span	Multi span	Single span	Double span	Multi span				
13.5/3	Steel (H, HDS, P & LG)	0.7	6.90	0.37	1.00	1.00	-	1.21	1.47	8000	30	NA	10
R32	Steel (H, HDS, P & LG)	0.7	6.76	1.38	1.24	1.50	1.47	1.75	2.18	16000	40	400	4
	Aluminium (MF, SA & CA)	0.9	2.99	0.60	1.18	1.42	0.90	1.59	1.98	16000	40	1000	4
R35	Steel (H, HDS, P & LG)	0.7	7.08	2.11	1.81	2.18	2.43	2.56	3.19	16000	55	NA	4
R46	Steel (H, HDS, P & LG)	0.7	7.36	3.01	1.82	2.15	3.87	4.07	5.10	16000	55	400	4
	Aluminium (MF, SA & CA)	0.9	3.25	1.74	1.63	1.92	2.31	3.61	4.51	16000	55	1000	4

Key:

- H – Colorcoat HPS200 Ultra®
 - HDS – Colorcoat HPS200 Ultra® double sided
 - P – Colorcoat Prisma®
 - LG – Colorcoat® LG
 - MF – Mill finish aluminium
 - SA – Stucco embossed aluminium**
 - CA – Pre painted aluminium**
- For an up to date list of our standard colours please contact our sales department.

- * Measured to inside face.
- ** Subject to min order quantities.
- *** Min. pitch after design deflections.

Profile manufacturing tolerance (This applies to all profiles)

Cover width (mm)	± 5
Squareness (mm)	< 0.5% of cover width
Length (mm) < 3m	+ 10, -5
Length (mm) > 3m	+ 20, -5

Tolerance is in accordance with BS EN 14782

General reference

All measurements throughout this brochure are referenced in mm unless stated otherwise. Technical illustrations are not to scale.

Wall profiles

Tata Steel offer an attractive and economic range of wall profiles to meet the aesthetic requirements of the designer.

Load/span figures

The load/span information in the table below is based on a span of 1.5m and a deflection limit of L/150 and should be used as a guide only. For full load span table information please visit our website or contact the Technical Department.

Curving

The factory curved data relates to a single convex curve.

For information regarding double or wave curves please contact our Technical Department on:

T: +44 (0) 1244 892199

E: technical.envelopeproducts@tatasteelurope.com

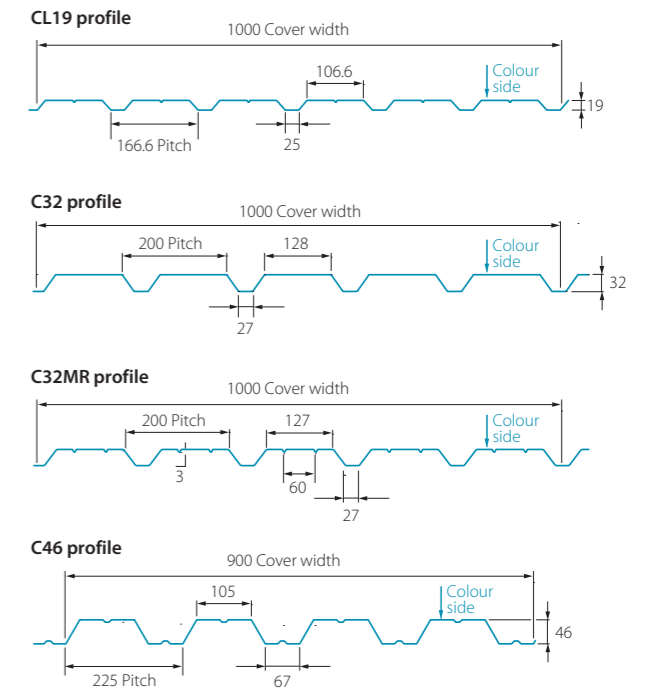

Note: all measurements in diagrams are in mm.

Wall profile range

Profile	Material and available finish	Gauge (mm)	Weight (kg/m ²)	Max. load for a 1.5m span						Max. sheet length	Min. factory curve (mm)*	Suitable for horizontal use?
				Imposed load (kN/m ²)			Wind suction load (kN/m ²)					
				Single span	Double span	Multi span	Single span	Double span	Multi span			
13.5/3	Steel (H, HDS, P & LG)	0.7	6.90	1.01	1.60	1.94	1.01	1.60	1.94	8000	NA	Yes
	Aluminium (MF, SA & CA)	0.9	3.05	0.48	1.15	1.15	0.48	1.15	1.15	8000	NA	Yes***
CL19	Steel (H, HDS, P & LG)	0.5	4.53	0.53	0.74	0.89	0.79	0.84	1.05	10000	350	No
	Steel (H, HDS, P & LG)	0.7	6.34	0.91	1.35	1.64	1.22	1.50	1.88	10000	400	Yes***
C32 and C32MR	Steel (H, HDS, P & LG)	0.5	4.83	1.37	0.92	1.09	1.38	1.37	1.71	16000	400	No
	Steel (H, HDS, P & LG)	0.7	6.77	2.38	1.74	2.09	2.46	2.38	2.98	16000	400	Yes*** (MR only)
C46	Aluminium (MF, SA & CA)	0.9	2.99	1.49	1.58	1.89	1.45	2.31	2.89	16000	1000	Yes*** (MR only)
	Steel (H, HDS, P & LG)	0.5	5.25	1.78	1.26	1.47	3.45	3.08	3.86	16000	400	No
C46	Steel (H, HDS, P & LG)	0.7	7.36	3.67	2.44	2.86	5.82	5.50	6.88	16000	400	Yes***
	Aluminium (MF, SA & CA)	0.9	3.25	2.99	2.10	2.44	2.99	2.06	2.39	16000	1000	Yes***

Key:

- H – Colorcoat HPS200 Ultra®
- HDS – Colorcoat HPS200 Ultra® double sided
- P – Colorcoat Prisma®
- LG – Colorcoat® LG
- MF – Mill finish aluminium
- SA – Stucco embossed aluminium**
- CA – Pre painted aluminium**

For an up to date list of our standard colours please contact our sales department.

- * Measured to inside face.
- ** Subject to min order quantities.
- *** For horizontal cladding Tata Steel recommend the allowable variation in the outer flange level of the cladding rail with respect to a vertical datum line is L/600 (where L is the rail spacing).

Special wall profiles

Tata Steel offer an attractive range of special order wall profiles in a range of finishes and colours to meet the aesthetic requirements of the designer.

Further information

For further information on span tables, profile self weight, gauge options, external finish options and colour range please contact us for further information on +44 (0) 1244 892199.

Plank profiles

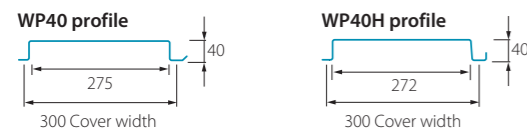
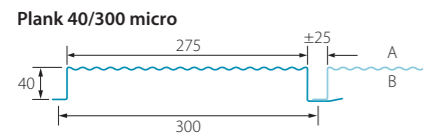
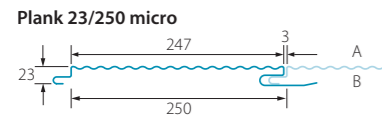
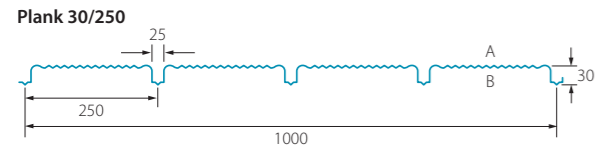

Fabrications

Tata Steel supply fabrications in a variety of girths to suit individual customers' requirements.

Alternative lengths are available upon request in girths between 250mm and 600mm. For high quality finishes a strippable film can be applied to the external surface for additional protection from scratches and scuff marks during subsequent handling and fixing.

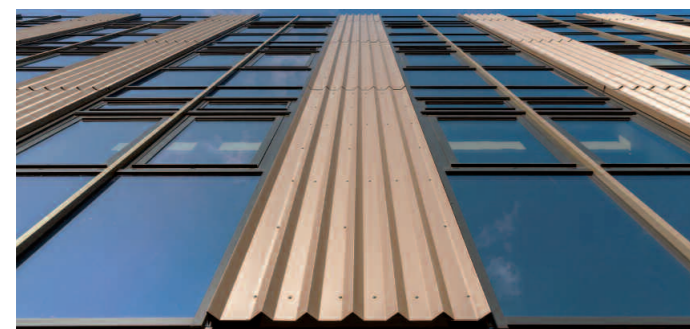

Sinusoidal profiles

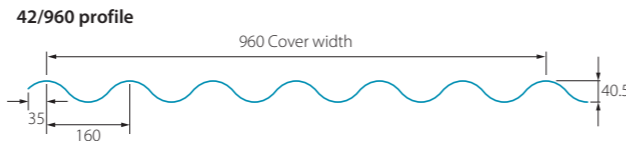
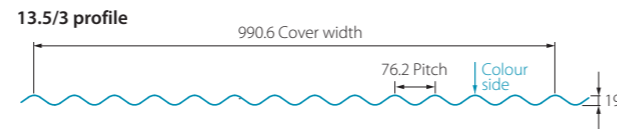

Pyramid profiles

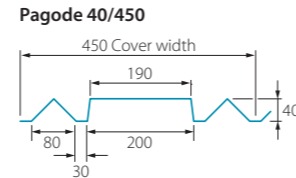
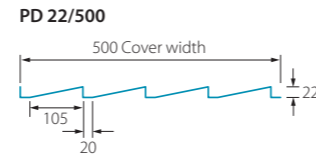
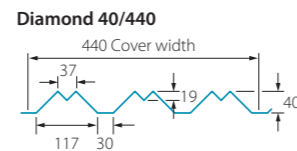
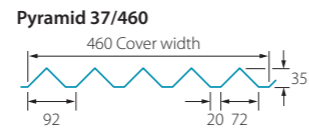
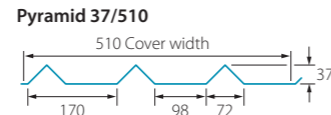

Special profiles

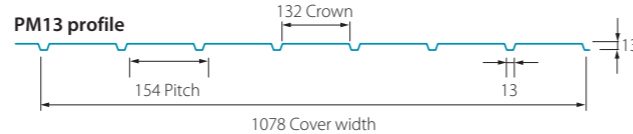
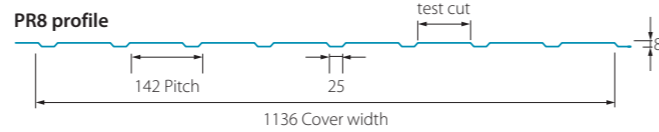
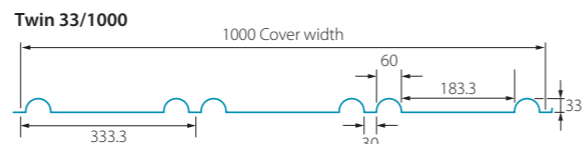

Note: all measurements in diagrams are in mm.

Oban High School, Argyll (see front cover image)
 Client: Oban High School
 Architect: Ryder Architecture
 Cladding contractor: Chemplas
 Tata Steel products: Trisobuild® C32/1000 and Trisobuild® Pyramid 50/1000
 Colorcoat® product: Colorcoat Prisma®

Tailored profile range

You can create expressive designs, putting your own stamp on your building, using our Trisobuild® tailored profile range. Architecturally inspired façades built from an exclusive offering from Tata Steel, available in the Colorcoat Prisma® pre-finished steel range of colours, perfectly complementing one another.

Whatever functionality or aesthetic appeal is sought there is a solution in Tata Steel's profiles range, which has been expanded with new styles that can be tailored to create a unique aesthetic. The exciting new profile shapes offer unparalleled creative freedom for building modern and contemporary looking structures that will provide truly unique and sensational building façades.

For more details and to view the full range visit our website or contact the Technical Department on:
 T: +44 (0) 1244 892199
 E: technical.envelopeproducts@tatasteelurope.com
 www.tatasteelconstruction.com

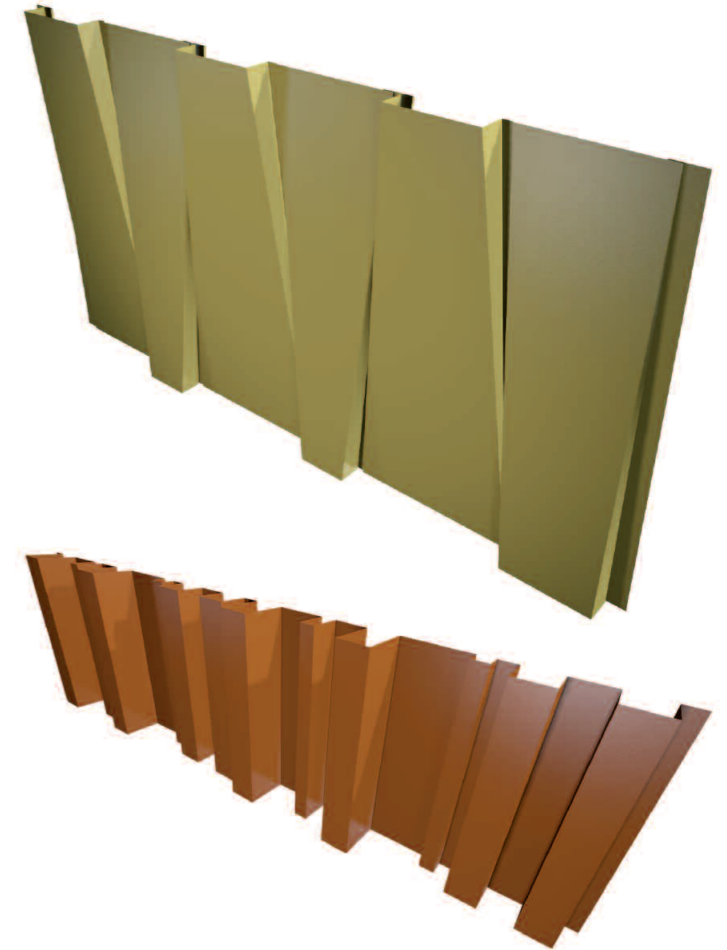

Liner profiles

Tata Steel offer a range of liner profiles, which provide an attractive clean and highly reflective internal appearance. The RL32 liner can offer a working platform during the construction phase when specified non-perforated. When the RL32 is perforated it can facilitate various acoustic specifications, however should be classed as fragile.

Lengths

Long lengths are available, however for practical site handling purposes when using the 0.40mm gauge we would suggest these are kept to a maximum of 5.5m.

Spans

In a roof application, the spanning capabilities of the liner profiles are largely dependent upon their self-weight and the weight of the insulation they are required to support. If a working platform is required we recommend the RL32 in a 0.7mm steel thickness. If a non-fragility rating is required a maximum span and fixing arrangement will need to be specified, for further information on non-fragility specifications, see page 11.

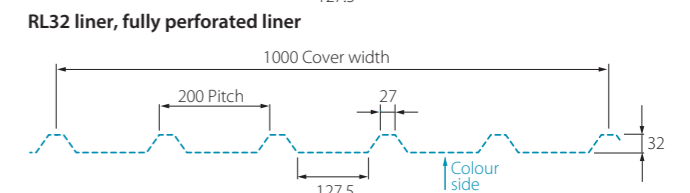
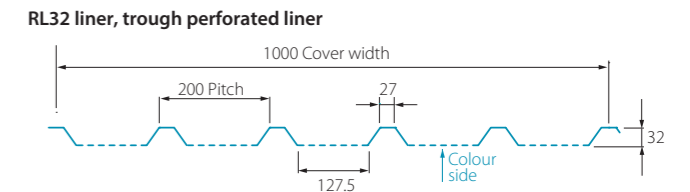
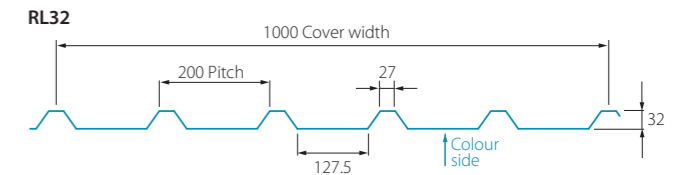
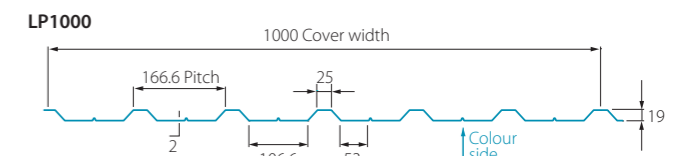

For structural decks and liner trays please refer to our RoofDek brochure, this can be found at www.tatasteelconstruction.com

Note: all measurements in diagrams are in mm.

Trisobuild® systems reference guide

The following codes are used as a quick reference within specifications, EPDs, construction drawings etc, to aid communication within dialogue between all parties in the specification process.

Help with specification creation:

Should you require help with creating your Platinum® Plus tailored specification please contact:
 T: +44 (0) 1244 892199
 E: technical.envelopeproducts@tatasteeleurope.com
 www.tatasteelconstruction.com/speccreator

Trisobuild® systems reference code example

(System reference) (External reference) – (Insulation/spacer depth) – (Liner profile reference)

VW R32 – 120 – LP1000

Trisobuild® systems reference codes

Roof

Code	Description
Trisobuild – R	Roof system (always uses LP1000 0.4mm liner)
Trisobuild – RWL	Roof system with liner (always uses walkable RL32 0.7mm liner)

Wall

Code	Description
Trisobuild – VW	Vertical Wall systems
Trisobuild – HW	Horizontal Wall systems

Fire wall codes

These are to be applied before the initial code eg, FW60-WWC32-180-LP1000

Code	Description
FW15V or H	Fire Wall system giving 15 mins insulation and 4 hrs integrity
FW30V or H	Fire Wall system giving 30 mins insulation and 4 hrs integrity
FW60V or H	Fire Wall system giving 60 mins insulation and 4 hrs integrity

Acoustic system codes

These are to be applied after initial code (can be used for both roof or wall, eg, SR38-VW-C32-180-R32 or SA1* (50)-RWL-R32-120-RL32

Code	Description
SR (value)	Sound Reduction system with predicted Weight SRi value after code
SA1 (slab depth)	Sound Absorption system – RL32 0.7mm liner with standard trough perforations without trough fillers
SA1* (slab depth)	Sound Absorption system – RL32 0.7mm liner with standard trough perforations with trough fillers
SA2 (slab depth)	Sound Absorption system – RL32 0.7mm fully perforated liner without trough fillers
SA2* (slab depth)	Sound Absorption system – RL32 0.7mm fully perforated liner with trough fillers

Trinsul®

The overall thickness (t) should be quoted after the initial code eg, Trinsul-M-160.

Code	Description
Trinsul-M	The Trinsul® system with a 85kg/m³ mineral fibre core
Trinsul-D	The Trinsul® system with a 140kg/m³ core

Trisobuild® R and RWL systems

The Trisobuild® R system comprises of a standard LP1000 steel 0.4mm liner. The RWL system uses the 0.7mm steel RL32 as its liner, which is a robust walkable liner.

Both systems can be spaced according to the required U-value requirement using Tata Steel's Instaloc® Plus spacer system.

Trisobuild® R system

Bracket height (mm)	Insulation depth (mm)	U-value (W/m²K)
140	140	0.30
160	160	0.26
180	180	0.24
200	200	0.21
220	220	0.19
240	240	0.18
260	260	0.16
280	280	0.15
300	300	0.14

Trisobuild® RWL system

Bracket height (mm)	Insulation depth (mm)	U-value (W/m²K)
140	140	0.32
160	160	0.28
180	180	0.25
200	200	0.22
220	220	0.20
240	240	0.18
260	260	0.17
280	280	0.16
300	300	0.15

U-values are based on secondary steelwork support at 1.8m centres, 1.2m bracket spacing and insulation with a 0.040W/mK thermal conductivity.

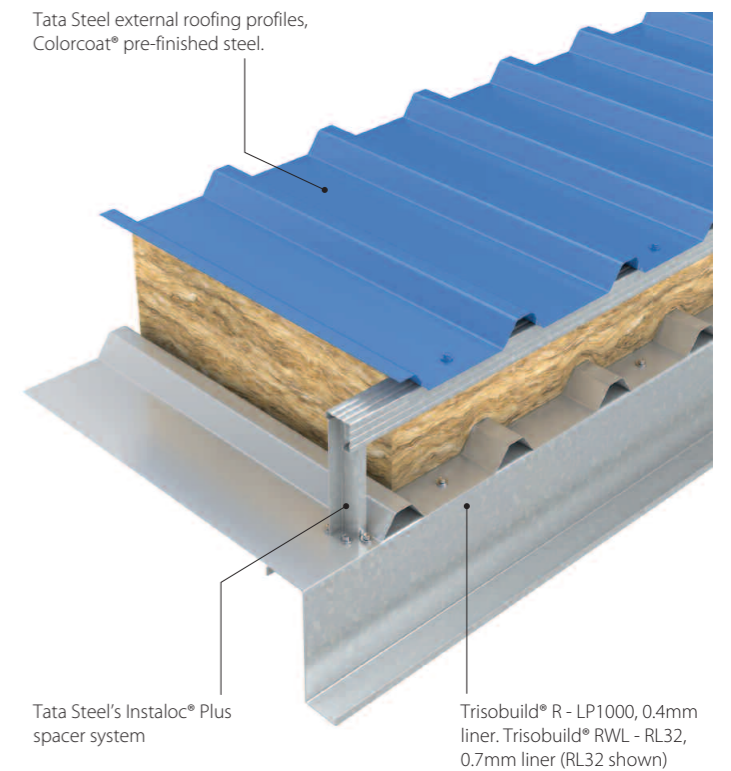

Liner non fragility fixing arrangement

Constructions tested and assessed in accordance with ACR[M]001:2011 Test For Non-Fragility of Profiled Sheeted Roofing Assemblies (third edition).

LP1000 0.4mm steel liner (R)

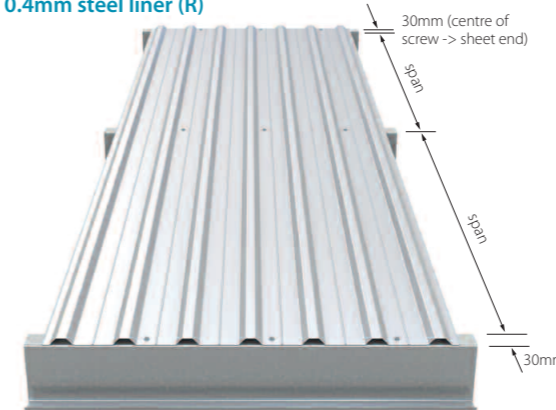

Span arrangement:	Double span
Maximum span:	1,800mm
Number of fixings:	3 per sheet at all supports
Min. end distance:	30mm
Fastener washer size:	19mm
Result:	Class C non-fragile

RL32 0.7mm steel liner (RWL)

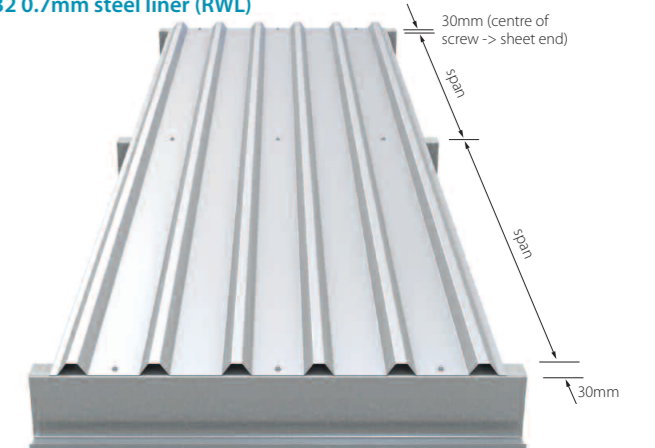

Span arrangement:	Double span
Maximum span:	2,000mm
Number of fixings:	3 per sheet at all supports
Min. end distance:	30mm
Fastener washer size:	19mm
Result:	Class B non-fragile

Trisobuild® CR system

The Trisobuild® CR system is a tried and tested assembly with a through fixed trapezoidal outer sheet which can self-curve around a range of radii. The system is specified with an apex sheet long enough to ensure that the end lap of the profile or roof light is below the 4 degree pitch of the curve. Designing the roof and using Trisobuild® CR within this radius range allows the specifier to optimise cost and provide an attractive low profile roof, with the confidence that all detailing has been third-party assessed.

Fixing instructions

Follow the guidance table above to ensure that the position of the first down slope end lap is at a pitch of 4 degrees or higher. The end lap sealant specification follows the same 6x5mm high performance strip sealant as the standard Trisobuild® roof system with two runs 15mm from both ends of the lap.

The apex sheet should be laid centrally to the peak of the curve and fixed systematically either side of the apex point with crown fasteners using saddle washers. This will pull the sheet around the curve, which can then be fixed at the end lap point using two fastener positioned at quarter points within the profile trough.

The side lap should be fixed with fasteners at a maximum of 450mm.

Fasteners downslope of this top end lap position can be more conventionally placed in every trough as shown below.

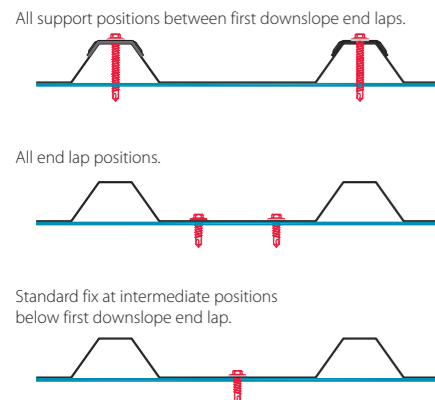

Radius (m)	40	45	50	55	60	65	70	75	80	85	90	95	100	105	110
Apex sheet length required for end lap at 4°	5.59	6.28	6.98	7.68	8.38	9.08	9.77	10.47	11.17	11.87	12.57	13.27	13.96	14.66	15.36

Table above assumes radius of roof is after designed deflection.

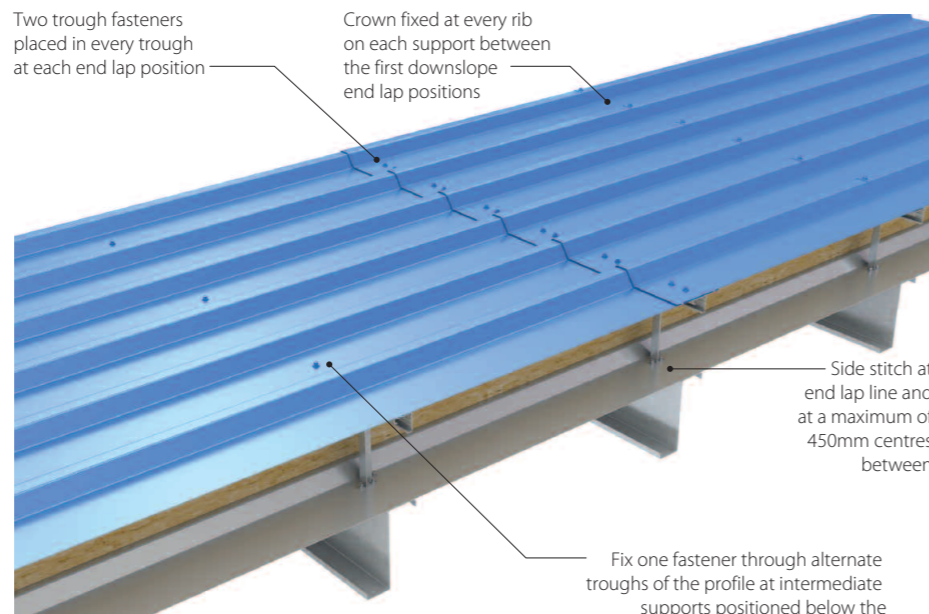
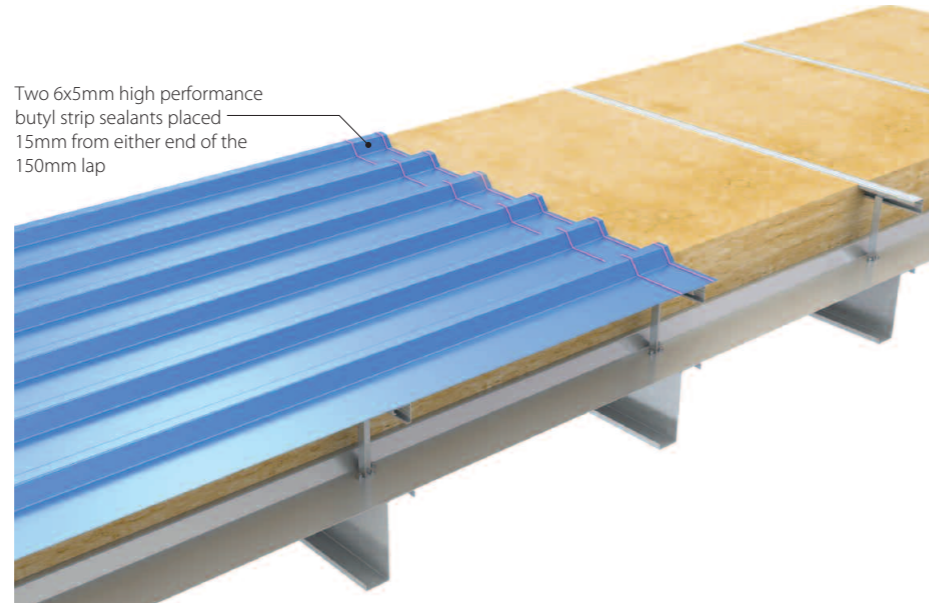

System testing

The Trisobuild® CR has been system tested independently, as recommended in BS 5427:2017 'Code of practice for the use of profiled sheet for roof and wall cladding'.

The testing was conducted at the BRE in accordance with BS EN 12865 'Hygrothermal performance of building components and building elements' which was felt the best method available for testing for driving rain and water penetration.

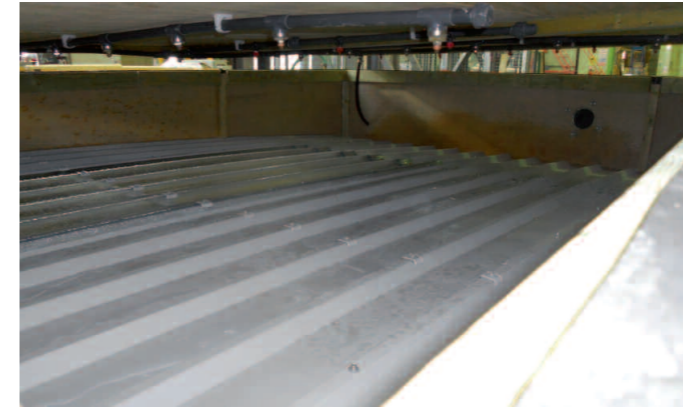

System constructed to 40m radii



Test apparatus built around specimen and pressurised



Trisobuild® acoustic systems



Acoustic performance is an increasingly important functional requirement for good building design. Whether it is reducing noise levels within a factory environment or eliminating nuisance from sound in residential areas, acoustic control is a significant aspect of steel cladding design. In recognition of this, Tata Steel have conducted a number of live acoustic tests. The results have produced a broad range of systems that meet sound reduction and sound absorption standards frequently specified by industry today. This section illustrates some of the tested and modelled Trisobuild® systems available for both sound reduction and sound absorption.

Trisobuild® sound reduction (SRI) systems

The procedure for determining the insulation of a construction against airborne sound is described in the standard BS EN ISO 10140-2.

The sound reduction index (SRI) at different frequencies is plotted against each level of sound frequency and quoted in decibels (dB).

Airborne noise may need to be considered for the requirements of the building for either, internal process noise breakout eg, factory in a residential area; or external noise break-in eg, airport terminal buildings.

Generally, noise with a lower frequency is more easily transmitted and the sound SRI figure at these levels is lower.

The weighted sound reduction index (Rw) is calculated by comparing the sixteen values of SRI from 100Hz to 3150Hz with a defined reference curve in accordance with BS EN ISO 717-1. This is then quoted as a single figure rating. A construction with a higher SRI has a better acoustic performance.

Trisobuild® built-up systems sound reduction predictions

SRI Weighted Values, Rw (dB)

Insulation and cavity thickness (mm)	Internal LP1000 Liner (0.4mm Steel)				Internal RL32 Liner (0.7mm Steel)			
	Glassfibre Insulation (nom. 12.5kg/m³)		Stonefibre Insulation (nom. 23kg/m³)		Glassfibre Insulation (nom. 12.5kg/m³)		Stonefibre Insulation (nom. 23kg/m³)	
	0.5mm External Profile	0.7mm External Profile	0.5mm External Profile	0.7mm External Profile	0.5mm External Profile	0.7mm External Profile	0.5mm External Profile	0.7mm External Profile
120	36.8	38.3	37.8	39.2	39.0	40.2	39.8	40.9
140	37.0	38.5	38.2	39.5	39.1	40.3	40.1	41.1
160	37.2	38.7	38.5	39.8	39.3	40.5	40.3	41.4
180	41.9	43.3	43.3	44.5	43.9	45.1	45.0	46.0
200	42.1	43.5	43.6	44.7	44.1	45.2	45.3	46.3
220	42.3	43.6	47.7	45.0	44.2	45.3	45.5	46.5
240	46.3	47.6	48.0	49.1	48.2	49.3	49.6	50.5
260	46.5	47.8	48.3	49.3	48.4	49.4	49.8	50.7
280	46.6	47.9	48.5	49.6	48.5	49.5	50.0	50.9
300	46.8	48.1	48.8	49.8	48.6	49.7	50.3	51.1
320	47.0	48.2	49.0	50.0	48.8	49.8	50.5	51.3
340	47.2	48.4	49.3	50.2	48.9	49.9	50.7	51.5
360	47.3	48.5	49.5	50.5	49.1	50.0	50.9	51.7
380	47.5	48.7	49.8	50.7	49.2	50.2	51.1	51.9
400	47.7	48.8	50.0	50.9	49.3	50.3	51.3	52.1

For information on individual frequency ratings please contact the Technical Department for Tata Steel's Building Systems UK. T: +44 (0) 1244 892199, E: technical.envelopeproducts@tatasteel.eu.com
 The acoustic performance of the profiled metal cladding construction detailed above has been predicted using the 2019 version of the computer programme developed by Tata Steel.
 CAUTION: The predicted SRI values should be used only to provide guidance for preliminary design and/or appraisal of cladding systems. Laboratory measurements should still be used to provide definitive acoustic data.

Trisobuild® systems sound absorption



The procedure for determining the sound absorption coefficient of a construction for airborne sound is described in standard BS EN ISO 354.

The way sound waves are reflected and absorbed will affect the overall noise level and the clarity of sound within the building. Perforations within the systems liner will allow sound absorption into the soft insulation layer and reduce sound reflection.

Sound absorption is used to reduce noise levels and improve the acoustics for different purposes in different kinds of rooms, eg, the promotion of speech intelligibility in rooms such as meeting and conference rooms, auditoriums and classrooms, and the reduction of disturbing noise from machines and equipment in office, healthcare and industrial buildings.

The greater the absorption co-efficient, the more the sound is absorbed in the structure.

- An absorption co-efficient of 0 means total reflection of sound.
- An absorption co-efficient of 1.0 means total absorption of sound. Co-efficients greater than 1.0 can be recorded due to the surface area being greater than plan area. In these cases 1.0 is used.

SA1 & SA2 systems

Trisobuild® SA1 and SA2 systems are tested assemblies that provide excellent sound absorption. Both systems use the RL32 as their liner profile with the SA1 being trough perforated and the SA2 being fully perforated, see below.

The troughs of the liner can either be left unfilled or stone wool trough fillers can be used to enhance the performance

A stone wool slab of density 60Kg/m² is used above the liner with a vapour control layer laid above this. A steel galvanised top hat stool creates support through this first insulation

layer for the spacer system which in turn supports the external profile and allows standard glass fibre quilt insulation to be added to fulfil the required U-value performance.

The tested systems have all used a minimal 100mm layer of quilt, however increasing this to meet lower insulation values will not reduce the absorption figures quoted.

See opposite a table showing the calculated U-values for various layers of quilt. The sound reduction figures obtained from the systems tests are shown on the next two pages.

U-value table for each both SA1 and SA2 systems based on slab depth of 50mm with varying quilt thickness (W/m²K).

Quilt (mm)	Troughs unfilled SA1 and SA2	Troughs filled SA1+ and SA2+
100	0.26	0.23
120	0.23	0.20
140	0.20	0.19
180	0.17	0.16

U-values are based on secondary steelwork support at 1.8m centres, 1.0m bracket spacing and insulation with a 0.040 W/mK thermal conductivity.

Liner perforation options

RL32 liner, trough perforated

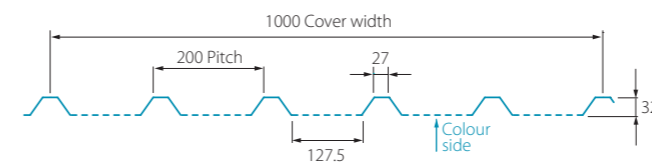

Circular perforations within the trough of the liner profile only, providing an open area of 22%.

RL32 liner, fully perforated

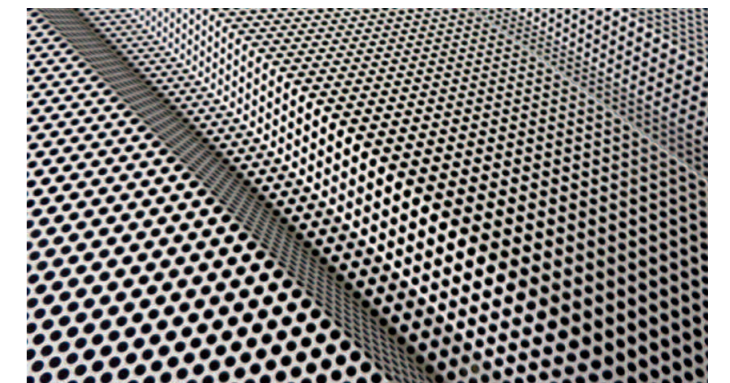
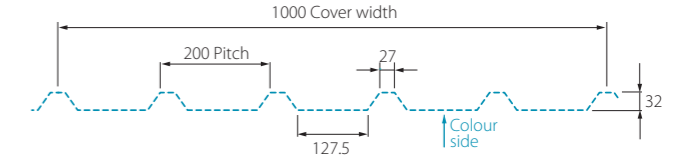

Fully perforated metal providing perforations to the full width of the liner profile, providing an open area of 46% and giving enhanced performance.

Trisobuild® sound absorption systems

Below are system drawings, descriptions and results for laboratory tested sound absorption solutions.

Trisobuild® SA1

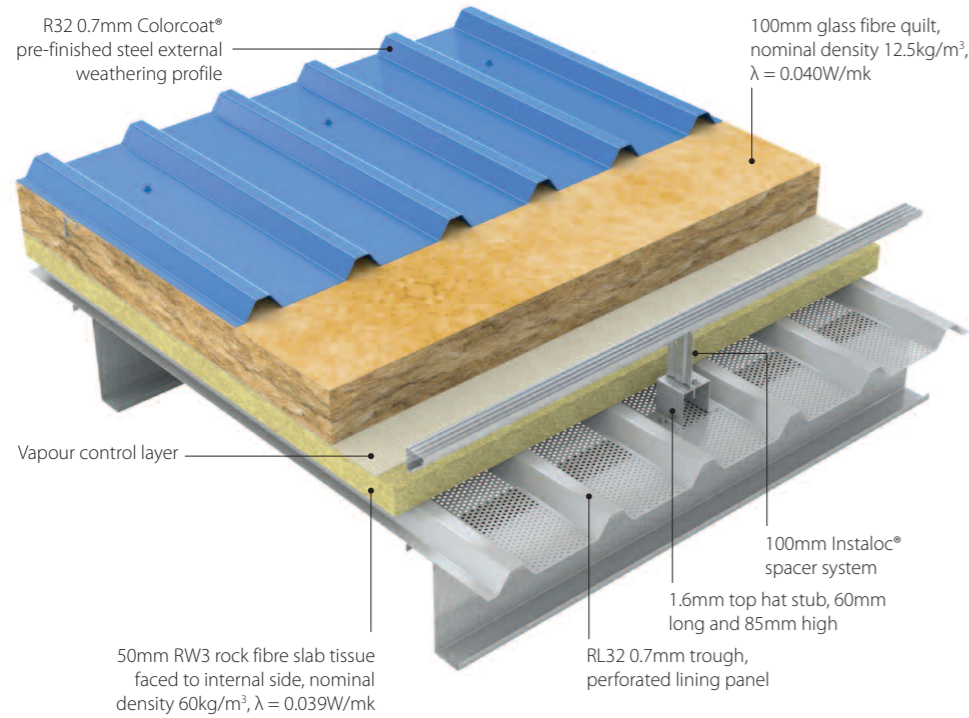

Frequency (Hz)	Sound absorption	
	α _s	α _p
50	0.28	
63	0.57	0.45
80	0.47	
100	0.74	
125	0.94	0.95
160	1.10	
200	1.06	
250	1.24	1.00
315	1.11	
400	1.06	
500	1.09	1.00
630	1.09	
800	1.09	
1000	1.01	1.00
1250	0.83	
1600	0.68	
2000	0.61	0.65
2500	0.63	
3150	0.66	
4000	0.63	0.65
5000	0.69	

Single figure rating: α_w = 0.75(LM), Sound absorption Class C.

The tested constructions are as drawn, deeper spacers and thicker layers of glass fibre quilt can be used for lower U-value requirements, and would not be expected to be detrimental to the acoustic performance.

Trisobuild® SA2

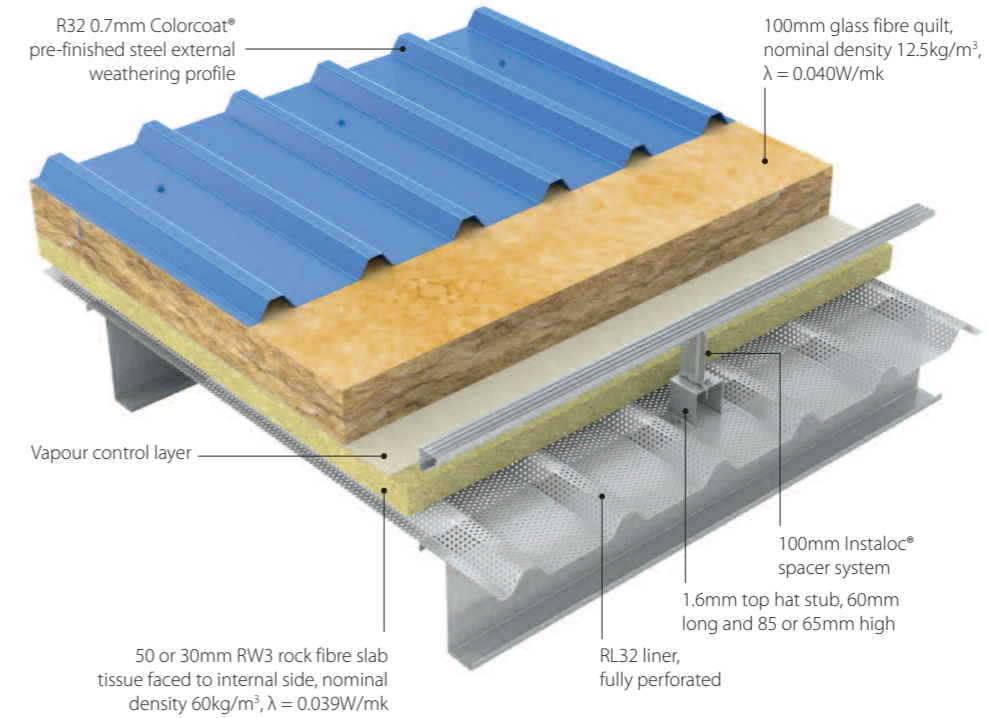

Trisobuild® built-up system

Frequency (Hz)	Sound absorption			
	Using 30mm RW3 slab		Using 50mm RW3 slab	
	α _s	α _p	α _s	α _p
50	0.30		0.37	
63	0.49	0.40	0.53	0.45
80	0.46		0.46	
100	0.72		0.84	
125	0.97	0.90	1.00	0.95
160	0.97		1.05	
200	1.16		1.11	
250	1.07	1.00	1.13	1.00
315	1.10		1.10	
400	1.09		1.09	
500	1.05	1.00	1.01	1.00
630	1.10		1.07	
800	1.02		1.02	
1000	1.04	1.00	1.06	1.00
1250	1.08		1.07	
1600	1.05		1.07	
2000	1.05	1.00	1.05	1.00
2500	1.06		1.06	
3150	1.07		1.09	
4000	1.02	1.00	1.10	1.00
5000	1.08		1.06	

Rating according to BS EN ISO 11654:1997 α_w = 1.00 Sound absorption Class A.

Trisobuild® SA1+

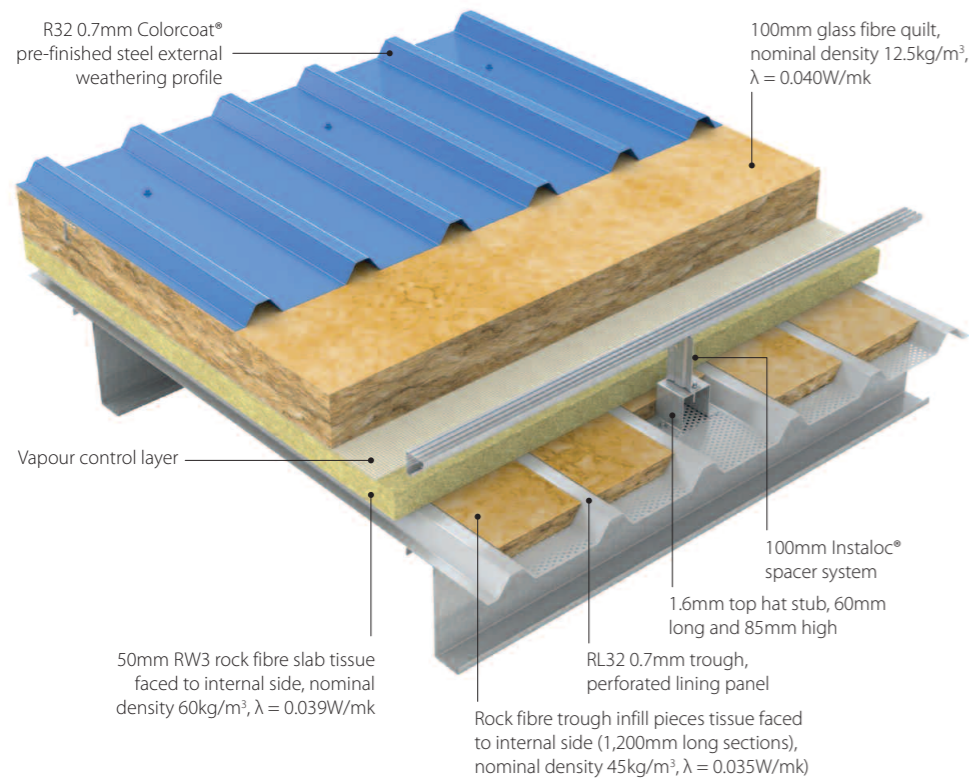

Frequency (Hz)	Sound absorption	
	α _s	α _p
50	0.26	
63	0.65	0.50
80	0.59	
100	0.90	
125	0.93	1.00
160	1.12	
200	1.14	
250	1.00	1.00
315	1.08	
400	1.08	
500	1.10	1.00
630	1.09	
800	1.05	
1000	0.99	1.00
1250	0.90	
1600	0.76	
2000	0.71	0.75
2500	0.72	
3150	0.74	
4000	0.67	0.70
5000	0.69	

Single figure rating: α_w = 1.00, Sound absorption Class B.

Trisobuild® SA2+

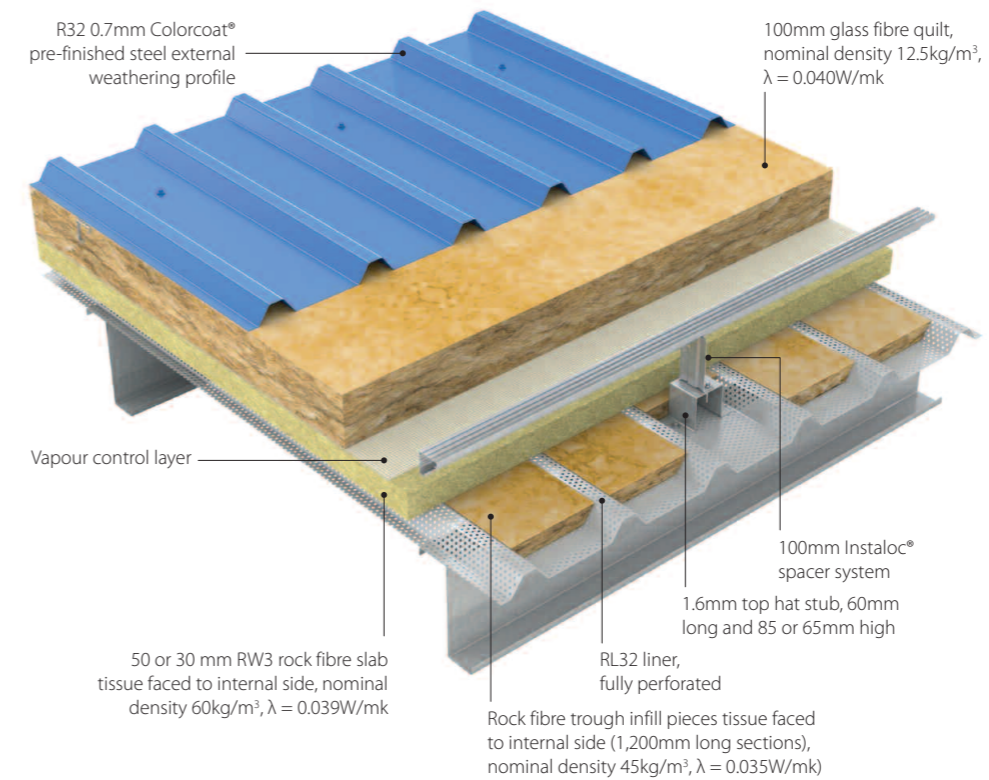

Fully perforated with 30mm slab and no trough infills

Frequency (Hz)	Sound absorption			
	Using 30mm RW3 slab		Using 50mm RW3 slab	
	α _s	α _p	α _s	α _p
50	0.21		0.33	
63	0.40	0.30	0.47	0.40
80	0.34		0.46	
100	0.63		0.73	
125	0.89	0.85	1.03	0.95
160	1.05		1.05	
200	1.11		1.09	
250	1.10	1.00	1.04	1.00
315	1.13		1.09	
400	1.10		1.07	
500	1.09	1.00	1.00	1.00
630	1.05		1.01	
800	1.02		1.02	
1000	0.99	1.00	0.98	1.00
1250	1.02		0.98	
1600	1.01		1.04	
2000	0.98	1.00	1.01	1.00
2500	0.98		0.98	
3150	1.04		1.00	
4000	1.01	1.00	1.01	1.00
5000	1.02		1.00	

Rating according to BS EN ISO 11654:1997 α_w = 1.00 Sound absorption Class A.

Trisobuild® wall systems

Trisobuild® VW systems

The Trisobuild® VW system is a vertically run wall system that can provide an efficient and attractive look to the external cladding.

The system provides the designer with an infinite number of combinations to create a unique aesthetic.

The capability of the systems can also allow the designer to specify the correct performance for the building and elevation. With tested components the system provides a range of thermal, acoustic and fire resistance performance levels.

The adaptability of the system allows the designer to specify the correct performance for the building and elevation.

Bracket height (mm)	Insulation depth (mm)	U-value (W/m²K)
140	140	0.30
160	160	0.26
180	180	0.23
200	200	0.21
220	220	0.19
240	240	0.18
260	260	0.16
280	280	0.15
300	300	0.14

U-values are based on a LP1000 liner, secondary steelwork support at 1.5m centres, 1.2m bracket spacing and insulation with a 0.040W/mK thermal conductivity.

Trisobuild® HW systems

The Trisobuild® HW system is a horizontally run external wall system that allows the secondary steelwork to remain horizontal with the spare and bar system spanning vertically between these rails.

The capability of the system the system has again been comprehensively tested to provide a range of performances.

Bracket height (mm)	Insulation depth (mm)	U-value (W/m²K)
120	140	0.35
140	140	0.30
160	160	0.26
180	180	0.23
200	200	0.21

U-values are based on a LP1000 liner, secondary steelwork support and brackets at 1.5m centres, 1.5m vertical bar spacing and insulation with a 0.040W/mK thermal conductivity.

Trisobuild® vertical wall system



Trisobuild® horizontal wall system

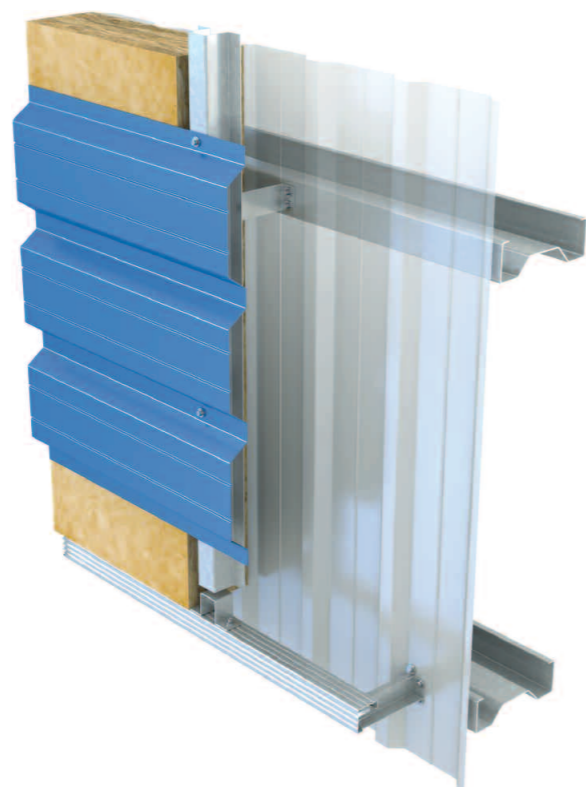

Trisobuild® - Fire performance



Approved Document B (fire safety) volume 2

The latest edition of Approved Document B sets out the full regulations covering fire safety within and around non-domestic buildings. Listed below is a summary covering the main building elements and levels of performance for the Trisobuild® systems. These are inline and with the recommendations given in the Approved Document. For further information on these or other aspects of fire design please contact our Technical Department.

Resisting fire spread over external walls

The guidance in this section is designed to reduce the risk of vertical fire spread as well as the risk of ignition from flames coming from adjacent buildings.

When used as an external wall Trisobuild® systems using a Colorcoat HPS200 Ultra® as their external finish can be used where B s3 d2 or equivalent is required in accordance with Table 12.1 (note 2) of the Approved Document B (fire). This allows use in all building types except for 'Relevant buildings' as defined in regulation 7(4). For buildings of this type Colorcoat Prisma® should be used as the external finish.

Resisting fire spread over roof coverings

This deals with the roof of the building and its adequacy to resist the spread of fire over the roof and from one building to another.

The performance of the resistance of roofs to external fire exposure is measured in terms of penetration through the roof construction and the spread of flame over its surface. Roof constructions are classified from a B_{ROOF}(t4) to F_{ROOF}(t4) where B_{ROOF}(t4) indicates the highest performance.

Reaction to fire performance of internal surfaces of walls and ceilings

The approved document describes internal linings as the materials or products used in lining any partition, wall, ceiling or other internal structure.

Clause 6.1 of the Approved Document states that the surface linings of walls and ceilings should meet the classifications in Table 6.1. Standard Colorcoat® PE 15 lining finishes used within our Trisobuild® systems comply with all criteria set out in table 6.1.

Resisting fire spread from one building to another

The fire resistance of a wall depends on its distance from the relevant boundary. This is in terms of the area of fire resistance needed to the elevation and the resistance performance of those areas. Separation distances are measured to boundaries to ensure that the location and design of buildings on adjoining sites have no influence on the building under construction. Trisobuild® FW systems on the next page provide details of specification and performance levels.

External reaction to fire class⁽¹⁾

Trisobuild® VW / HW systems	Colorcoat HPS200 Ultra®	Colorcoat Prisma®
	Can be used where B s3 d2 is required ⁽²⁾	A1

(1) - Clause 12.5 The external surface (ie outermost external material) of external walls should comply with the provisions in Table 12.1.

(2) - Table 12.1 (Note 2) - Profiled of flat steel sheet at least 0.5mm thick with an organic coating of no more than 0.2mm thickness is also acceptable (ref to Class B s3 d2).

External fire exposure to roofs

Trisobuild® VW / HW systems	Colorcoat HPS200 Ultra®	Colorcoat Prisma®
	B _{ROOF} (t4)	⁽¹⁾

(1) - Systems using Colorcoat Prisma® are defined in Commission Decision 2000/553/ EC of 6th September 2000, implementing Council Directive 89/106/EEC and can be considered to fulfil all of the requirements for the performance characteristic 'external fire performance' without the need for testing.

Insurance requirements

Trisobuild® systems can meet the requirements of insurance based tests and are approved to LPS 1181-1 by the Loss Prevention Council Board (LPCB).

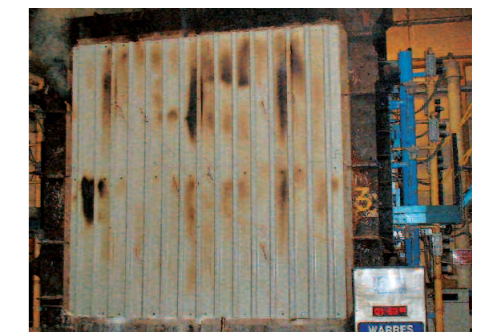

LPS1181:1 Approved
460a, 14, 15, 19, 23 & 31

Trisobuild® vertical fire wall systems



Trisobuild® FW15V SA

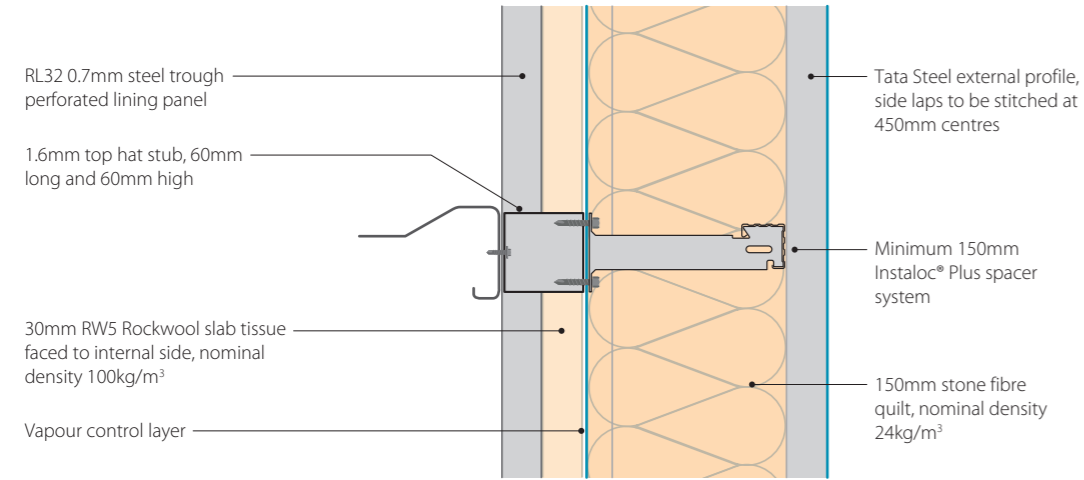

Integrity	Insulation
240 minutes	15 minutes

Trisobuild® FW30V

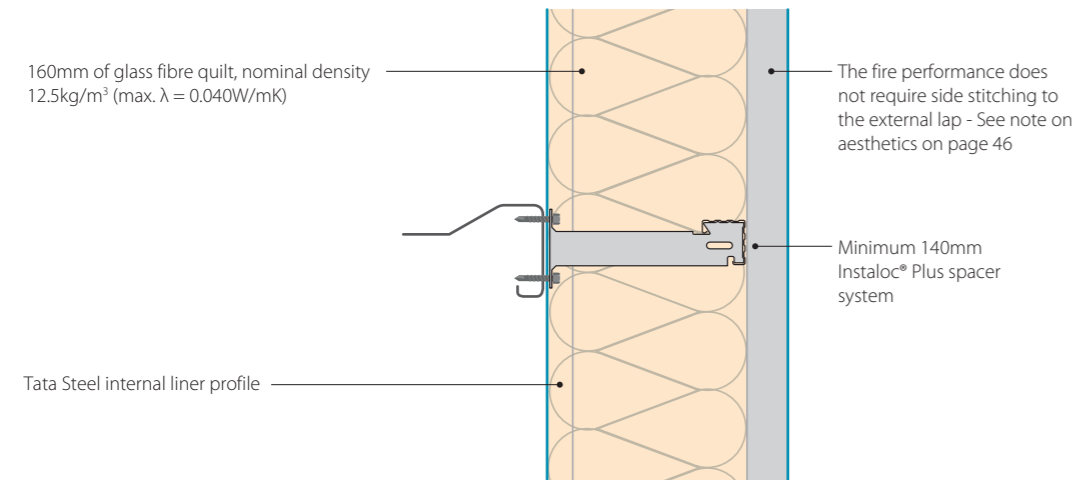

Integrity	Insulation
240 minutes	30 minutes

Trisobuild® FW60V

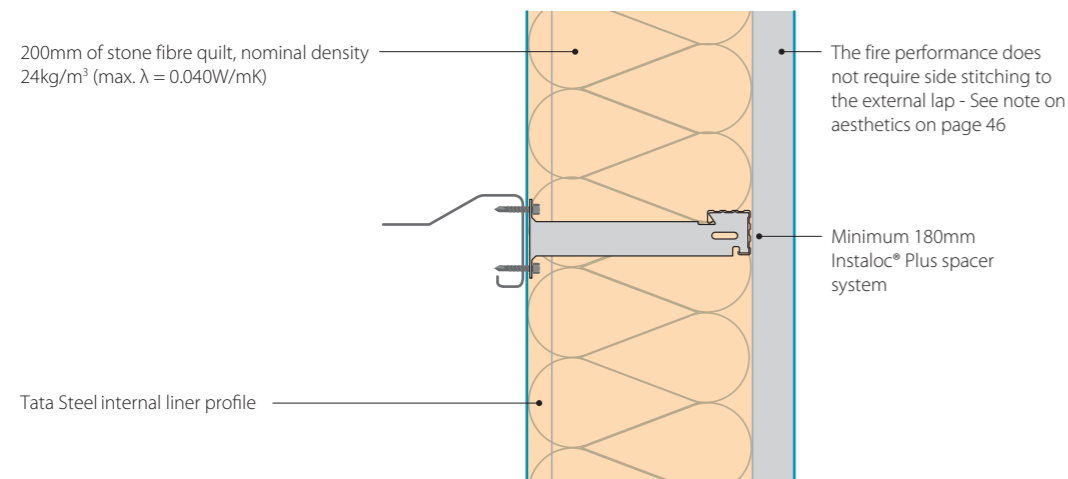

Integrity	Insulation
240 minutes	60 minutes

All fire wall systems have a maximum span between supports of 2m.

Vertical sections

Trisobuild® horizontal fire wall systems



Trisobuild® FW15H

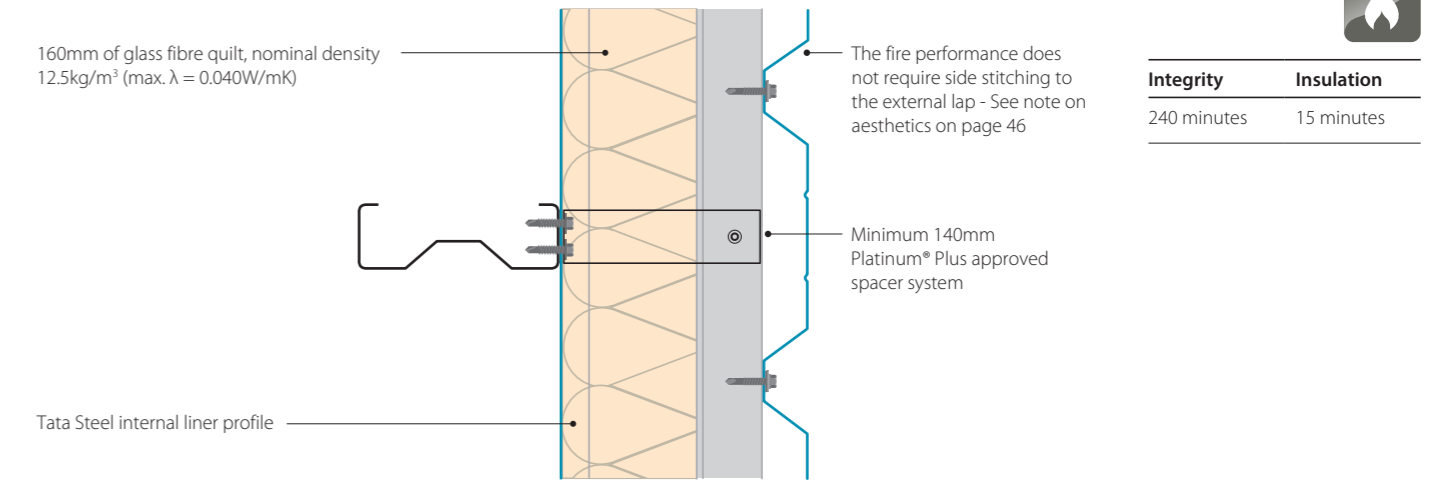

Integrity	Insulation
240 minutes	15 minutes

Trisobuild® FW30H

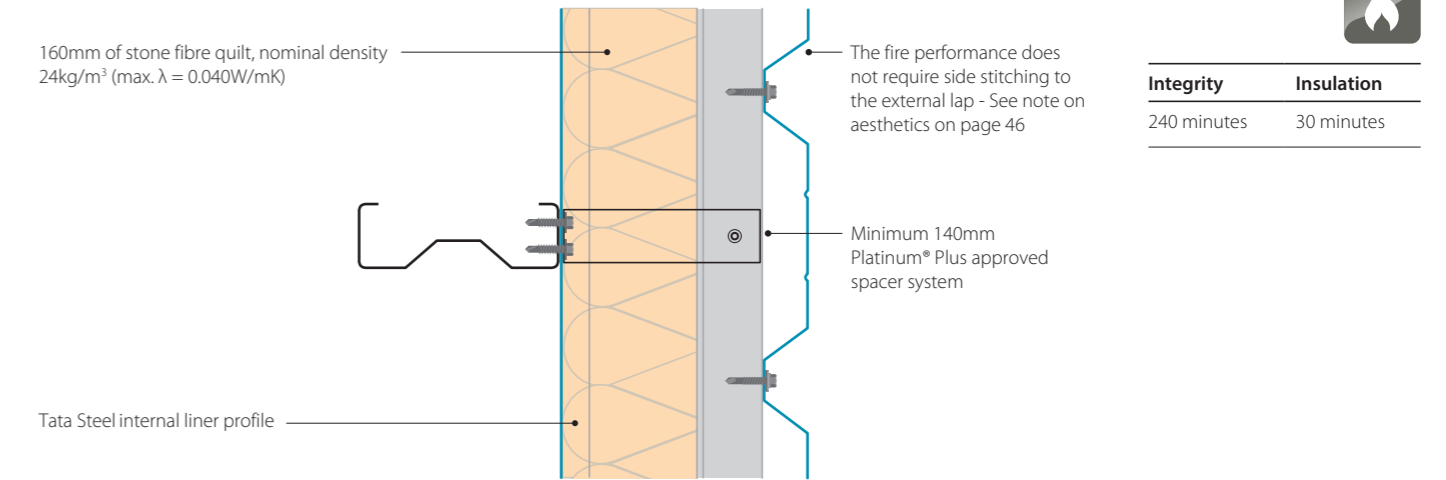

Integrity	Insulation
240 minutes	30 minutes

Trisobuild® FW60H

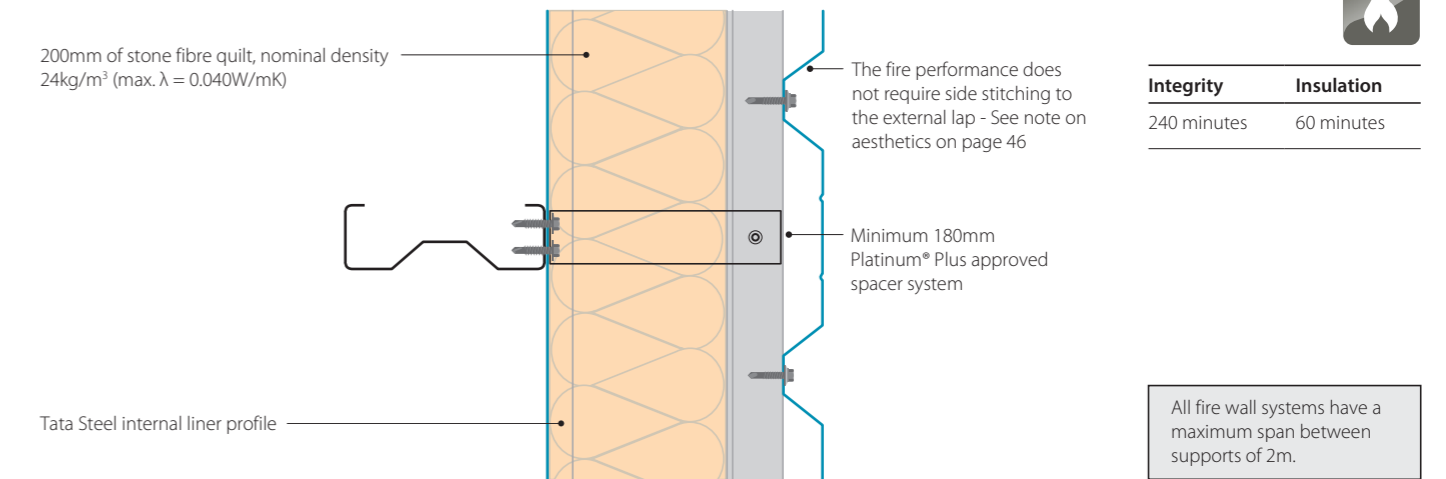

Integrity	Insulation
240 minutes	60 minutes

All fire wall systems have a maximum span between supports of 2m.

Vertical sections

Trinsul® system

The Trinsul® system is a site assembled composite cladding system, offering the performance of a composite panel plus the flexibility and ease of handling of standard single skin profiles.

The core of the system uses high-density rock fibre insulation, providing superb fire and acoustic properties, profiled to ensure there are no voids between the outer sheets and lining panel.

This also reduces cold bridging and makes the system highly resistant to condensation.

The Trinsul® system offers a highly consistent insulation performance and flexibility to offer a wide range of U-values.

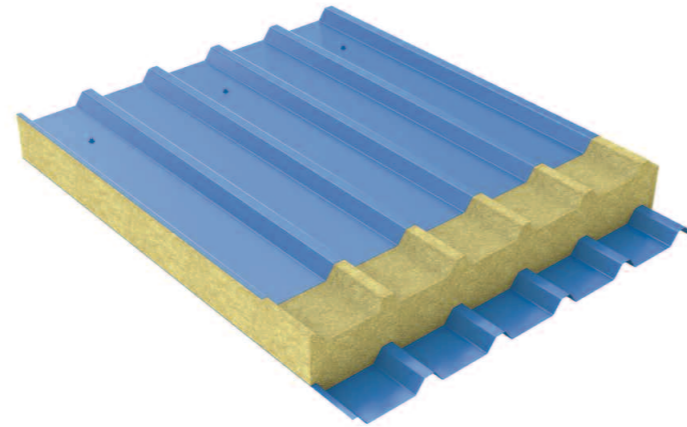

System options

The Trinsul® system is available in the following standard combinations of profile and liner, making use of standard load/span tables.

The profiled insulation core is available in medium dense and dense rock fibre.

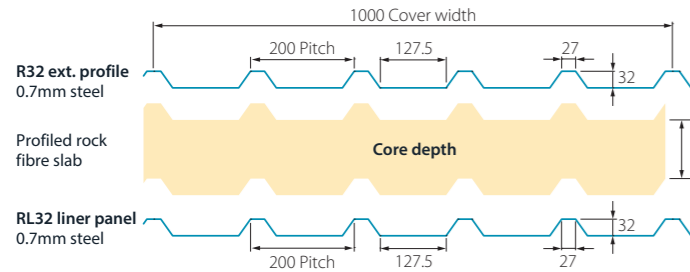

Fire resistance

Trinsul® systems offer Grade EXT-B and EXT-A60 approval by the LPCB together with approved fire resistance performance of up to 120 minutes insulation and 4 hours integrity.

The fire performance depends on the depth and density of rock fibre core selected, and is valid from either direction for all combinations of core and profile specification.

Medium dense core (85kg/m³ rock fibre slab)

Fire insulation (minutes)	Fire integrity (minutes)	Minimum core depth (mm)
60	240	80

Dense core (140kg/m³ rock fibre slab)

Fire insulation (minutes)	Fire integrity (minutes)	Minimum core depth (mm)
120	120	120

Thermal performance

The tables below indicate the U-values when calculated at 1.8m purlin centres.

These values have been computer modelled in accordance with EN ISO 10211.

The core thickness is the distance between the bottom face of the external steel and the top face of the internal steel, as shown in the diagram opposite.

U-values for R32 external profile, medium dense rock fibre slab, RL32 liner

Core thickness (mm)	Core type	Typical U-value (W/m²K)	System weight (kg/m²)
93	Medium dense	0.30	22.53
118	Medium dense	0.25	24.90
168	Medium dense	0.19	29.15

U-values for R32 external profile, dense rock fibre slab, RL32 liner

Core thickness (mm)	Core type	Typical U-value (W/m²K)	System weight (kg/m²)
128	Dense	0.26	33.67
168	Dense	0.20	39.27

Alternative slab thicknesses and profile options are available on request.

Colorcoat® products and services

Trisobuild® systems are supplied with Colorcoat® pre-finished steel for the external and internal skin so that we can provide the very highest quality and service to our customers.

Colorcoat® products and services

The Colorcoat® brand provides the recognised mark of quality and metal envelope expertise exclusively from Tata Steel. For 50 years Tata Steel has developed a range of technically leading Colorcoat® pre-finished steel products which have been comprehensively tested and manufactured to the highest quality standards. Colorcoat® products manufactured in the UK are certified to BES 6001 Responsible Sourcing standard and fully REACH compliant and free of chromates, including hexavalent chrome.

Colorcoat HPS200 Ultra®

Designed to withstand aggressive environments Colorcoat HPS200 Ultra® combines outstanding performance with exceptional durability to provide long-term integrity for the building envelope. Making it the first choice for aggressive internal and external applications. For more information visit www.colorcoat-online.com/ultra

Key benefits include:

- 40 standard colours in solid and matt shades.
- Surpasses requirements of Ruv4 and RCS as per EN 10169 proving outstanding colour retention and corrosion resistance.
- Optimised Galvalloy® metallic coating for exceptional corrosion resistance and cut edge protection.
- Scintilla® embossed as a mark of authenticity from Tata Steel.
- Repertoire® colour matching service for solid colours with a minimum order quantity of 5000m².
- Exceeds requirements of CPI5 as per EN 10169:2010 demonstrating excellent barrier properties when used internally.

Colorcoat Prisma®

The latest generation pre-finished steel product, three layer Colorcoat Prisma® utilises cutting-edge clear coat technology to provide an optimised pre-finished steel product that pushes the boundaries of UV and corrosion performance. Enabling a wide range of contemporary aesthetic colours, that are truly built to last. For more information visit www.colorcoat-online.com/prisma

Key benefits include:

- Wide range of standard colours including, natural metal colours, metallics, matts and metallic matts.
- Surpasses requirements of Ruv4 and RCS as per EN 10169 proving outstanding colour retention and corrosion resistance.
- Optimised Galvalloy® metallic coating for ultimate corrosion resistance and cut edge performance.
- Repertoire® colour matching service for solid colours with a minimum order quantity of 5000m².



Colorcoat® High Reflect

In addition to the standard liner, we also offer the Colorcoat® High Reflect as an option.

Key benefits include:

- ≥ 85% reflectance, reducing the amount of energy required to achieve the same level of lighting.
- Possible energy savings of up to 12% per year.
- Significantly reduces CO₂ emissions by 2-3% per year, helping you to achieve compliance with tightening regulations.

Confidex® Guarantee for up to 40 years

Offers the most comprehensive pre-finished steel guarantee for the weatherside of industrial and commercial buildings in Europe. Confidex® is project specific and upon online registration, is offered directly to the building owner with no inspection or maintenance to maintain its validity.

Can include cover for the pre-finished steel that is under photovoltaic (PV) frame modules, providing the building owner with the confidence that installing a PV array will not have a detrimental effect on the performance of the roof and that the whole roof is guaranteed to perform for the same duration of up to 40 years.

For more information about Colorcoat® products and services call the Colorcoat Connection® helpline on T: +44 (0) 1244 892434.

Confidex® provides a direct guarantee from Tata steel



Quality Assurance

Management

To provide the best quality service, Tata Steel is quality assured to Quality Management standard BS ISO 9001:2015. This management process puts quality at the heart of our business. Tata Steel's culture and the employment of quality control specialists that operate and police these policies ensure consistently high standards.

Environment

Tata Steel has a dedicated policy towards our surrounding environment, our energy use and management and control of our waste, shown and managed through our certification to the environmental standard BS EN ISO 14001:2015.

Present and future impact

Part of managing risk is thinking about how a building will perform in 30 or 50 years' time, when the unpredictability in our climate could be more extreme than it is now. Sourcing raw materials and using them responsibly is a part of designing resiliency into our built environment, protecting building users from the effects of changing climate, and reducing our impact on our surroundings.

As such our products and services have achieved certification to BES 6001, the

Responsible Sourcing Standard for construction products. We are also the world's first steel company to be approved to operate an Environmental Product Declaration programme. This means that we are now able to provide the market with third-party verified, product-specific EPDs for our construction products and the systems they become part of. This along with BES 6001 responsible sourcing certification, assists our construction supply chains to accrue points under building certification schemes, such as LEED and BREEAM, on their projects.



CE Marking

Tata Steel's cladding profiles are fully compliant with the regulations.

The Regulations are legally binding across the European Union (EU). Roof and wall cladding sheets are covered by BS EN 14782. This ensures the performance of cladding sheets are described in accordance with defined standards to allow direct comparison.

Importance of gauge

All the above mentioned controls over quality and material sourcing guarantee that the strength and gauge of steel supplied by Tata Steel are within the European tolerances.

The gauge of the pre-finished steel coil or sheet plays a vital role in the physical properties of the roof and wall cladding system of which it is a part. The gauge of the product can affect the safe span/load figures, the ability to resist concentrated loads, the systems non-fragility classification, visual appearance, and even the reaction to fire performance.

The actual gauge of a pre-finished steel product is measured using a micrometer and includes the steel substrate and metallic coatings, but excludes the paint and primer layers. The only accurate way to carry this out is to actually remove the paint coatings from the area to be measured, prior to measurement as shown below.

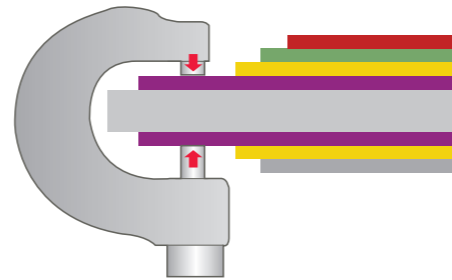

Key

- Topcoat
- Pre-treatment
- Substrate
- Primer
- Metallic coating
- Backing coat

Site guidance

This guide assumes that all current safety regulations are in place before the installers commence work.

Packaging

Packaging for the Trisobuild® systems external and liner profiles use loose timber packers, with the sheets banded together. Edge protectors are used in the location of the banding to prevent edge damage. An additional sheet of the same profile is used as the top sheet of each pack, to help protect the sheets below from scratching during transportation. The sheets are supplied in a maximum pack weight of 1,500kg.

Receipt of materials on-site

All materials arriving on-site must be checked promptly before offloading. Checks should be made against the relevant delivery notes to ensure that the correct quantities and specifications have been delivered and to determine any possible transportation damage. Any discrepancies or damage observed should be recorded immediately on the proof of delivery paperwork, and a written report should be submitted within 14 days. Please note that offloading is the customer's responsibility.

Offloading

Wherever possible, the profile packs should be offloaded directly from the vehicle to the area where they will be used to reduce the risk of on-site damage. Offloading is to be undertaken as per Tata Steel recommendations. If product is not to be installed shortly after its offload, the profile packs must be stored on level ground (in accordance with storage instructions below). Tata Steel can offer an offloading service, if requested prior to delivery.

There are two recommended methods for offloading:

- **Forklift or telehandler (on-site plant):**
These can be used when offloading profile packs less than 6m long. Care must be taken not to tip or damage the pack when driving on uneven ground. Only **one** pack at a time should be unloaded. Open forks fully before lifting.
- **Crane:** Where slings or grabs are used, precautions should be taken to prevent edge damage and to avoid pressure across the profile width, which may cause distortion (chains should not be used). When lifting packs over 8m long, a spreader bar with sufficient hoisting belts to spread the load should be used. If required, temporary edge protection can be installed to prevent local damage. Only **one** pack at a time should be offloaded.

Storage

In addition to the guidelines below, the bundles should be stored on level ground eg a floor slab. The packs should be stacked no more than three packs high, supports between packs should be kept in line and be at no more than 1.25m centres. There should be adequate separation between stacks to provide access and to avoid end damage.

Storage guidelines

- Do not stand uncovered stacks in the open. Store under cover and away from open doorways.
- If stacks cannot be stored under cover, erect a simple scaffold around them and cover it with a waterproof sheet, tarpaulin or polythene. Leave space between the cover and stacks to allow air to circulate.
- Store stacks off the ground and on a slope, so that if rain penetrates the cover, the water will drain away.
- Inspect the storage site regularly to ensure that moisture has not penetrated the stack.
- Do not store sheets where people will walk across them.

Pre-erection checks

A secondary support structure is necessary to support the cladding system at the required positions and transfer all loads imposed on and by the cladding system back to the primary structure.

Before any work starts, a full survey or inspection should be carried out to ensure that the support steelwork and any other associated materials are in the correct positions and are within tolerance so that the Trisobuild® systems can be fixed correctly. Any obvious problems should be reported immediately to the main contractor to enable remedial work to be undertaken before installation of the cladding.

Tata Steel recommendation for the allowable variation in the top flange level of the purlin with respect to a datum line running parallel to the rafter is L/200 (where L is the purlin spacing). For wall cladding the vertical datum should be within L/400 for vertical cladding and L/600 for horizontal cladding. Further guidance on steelwork tolerance is found in the Steel Construction Institute publication P346: *Best Practice for the specification in installation of metal cladding and secondary steelwork*.

Handling

When lifting individual profiles from the pack they should be lifted vertically without sliding, to avoid the risk of surface scratching to profile face below.

Due to the lightweight nature of the individual components used within the Trisobuild® systems mechanical handling is not normally required, and profiles can be positioned manually. However extra caution should be taken when using a 0.4mm liner and lengths should be limited to 5m.

Cutting

For all cuts we recommend using a nibbler. A grinding blade should not be used, as this hot cut will damage the coating. All cutting, wherever possible, should be undertaken at ground level. Where it is not possible to protect the site cut edge from weathering by a cover flashing, they should be treated with a suitable edge protection paint or lacquer.



London Victoria Station

Client: Network Rail

Main contractor: May Gurney

Design engineer: WSP

Tata Steel products: Trisobuild® R46 and PM13 profiles

Colorcoat® product: Colorcoat HPS200 Ultra®



Roof installation

Working on a roof is high-risk work, which requires the closest attention to detail at all times. There should be a job specific method statement in writing, agreed and understood by all parties before the work starts. Rigorous supervision is needed to ensure that the agreed method is followed in practice. Further guidance can be found in the Advisory Committee for Roofwork 'Orange Book' ACR[CP]001:2007 Rev.3 'Recommended Practice for Work on Profiled Sheeted Roofs'.

The steps given below are instructions for a typical construction and should be used only as a guide. An extended list of construction details is available from Tata Steel, and advice can be given via our Technical Department on any bespoke details that may be required.

Carry out preparation work on internal ridge, eaves and trim flashing etc, and ensure that these are lined and levelled and sealed as specified, before starting to lay liner sheet. When lifting packs onto the roof ensure that these are placed over a rafter line and secured.

The liner sheet can be used to quickly line out part or all of the roof elevation, this operation should always start at a rafter and move into the span of the purlins, with cladding installers working off 'Youngmans' boards or similar staging installing one tier at a time as shown below.

The liners should be fully fixed as per the non-fragility specifications on page 11 and sealed as specified on page 34. The spacer system should also be installed during this sequence, using 1m bars again working off staging and installing a tier at a time.

It is not advised, even when fully fixed, to walk on the LP1000 0.4mm liner, due to the risk of damage. If access is required across the liner (ie, lining the whole roof before returning to install the rest of the system) then the RL32, 0.7mm walkable liner should be used. The other advantage of using this profile is that longer lengths can be used. The insulation and external sheet should be laid in sequence from one edge of the roof using the fully fixed external sheets as a working platform.

When lifting external packs onto the spacer system ensure that these are placed over a rafter line, and consult the spacer manufacturer for any additional instructions to ensure the stability of the system.

When installing the insulation ensure all edges are close butt jointed to achieve continuity between spacers. The insulation can be installed in more than one layer, if so, the joints in each layer should be offset. The quilt must be cut and tucked under the spacer bar so that there is no air gap under the bar. It is important to keep the insulation dry.

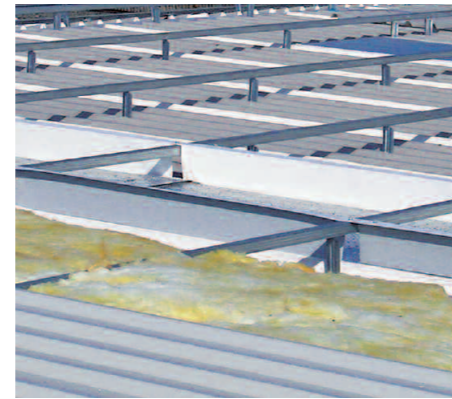

Where possible, the external sheets should be laid with the exposed joints of the side laps away from the prevailing wind unless shown otherwise on drawings. The outer sheets should be laid to the sequence shown in the diagram below, and sealed as specified on page 34. Advice should be obtained from our Technical Department on fastener layout, as this will depend on the calculated wind load for the cladding.

The contractor should ensure that all swarf and debris are removed from the surface of the external sheet as work progresses and should be inspected again after installation is completed.

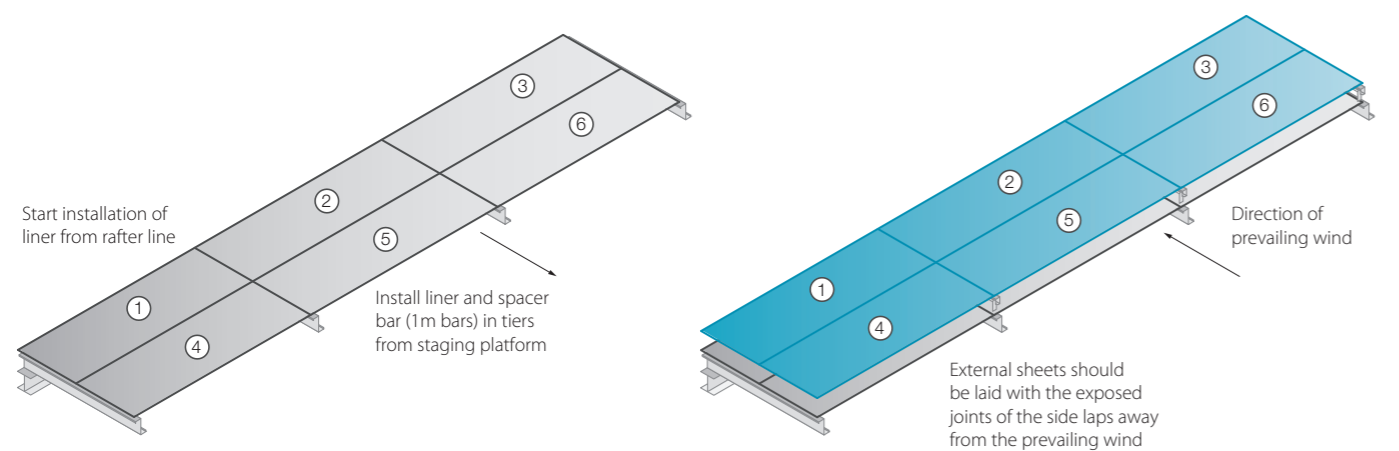

Construction details – roof

The details within this section are recommendations and have been designed to give practical solutions to minimise thermal bridging and air loss at junctions. For each junction detail, Ψ values (psi) and f values have been calculated in accordance with BS EN ISO 10211.

NB. All support steelwork by others.

Ridge

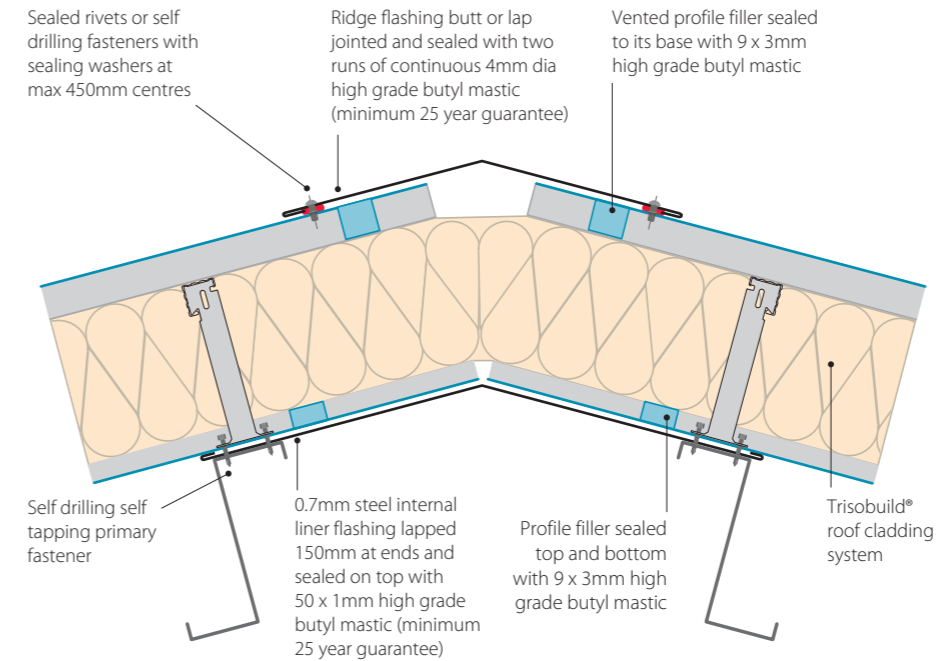

Ridge
Fillers should be positioned back from the edge of the ridge flashing by approximately 80mm to avoid the risk of bird attack.

Psi value (W/mK)	f factor
0.001	0.98

Stated calculation results are dependent on components being as shown. Computer modelled in accordance with EN ISO 10211.

Eaves

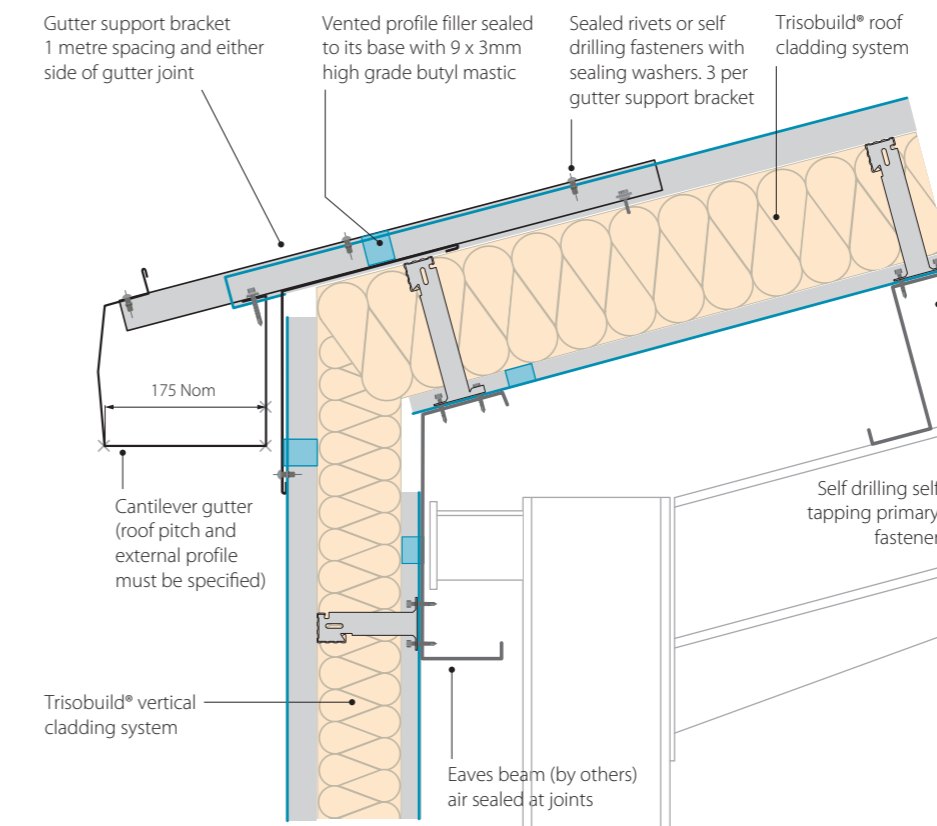

Eaves
The Cantilever Gutter system is manufactured to suit the pitch of the roof and downpipes can be positioned as required. For further information on the Cantilever Gutter system and assistance with rainflow calculations please contact the Technical Department T: +44 (0) 1244 892199 E: technical.envelopeproducts@tatasteel.com

Psi value (W/mK)	f factor
0.021	0.95

Stated calculation results are dependent on components being as shown. Computer modelled in accordance with EN ISO 10211.

Construction details – roof continued

Parapet

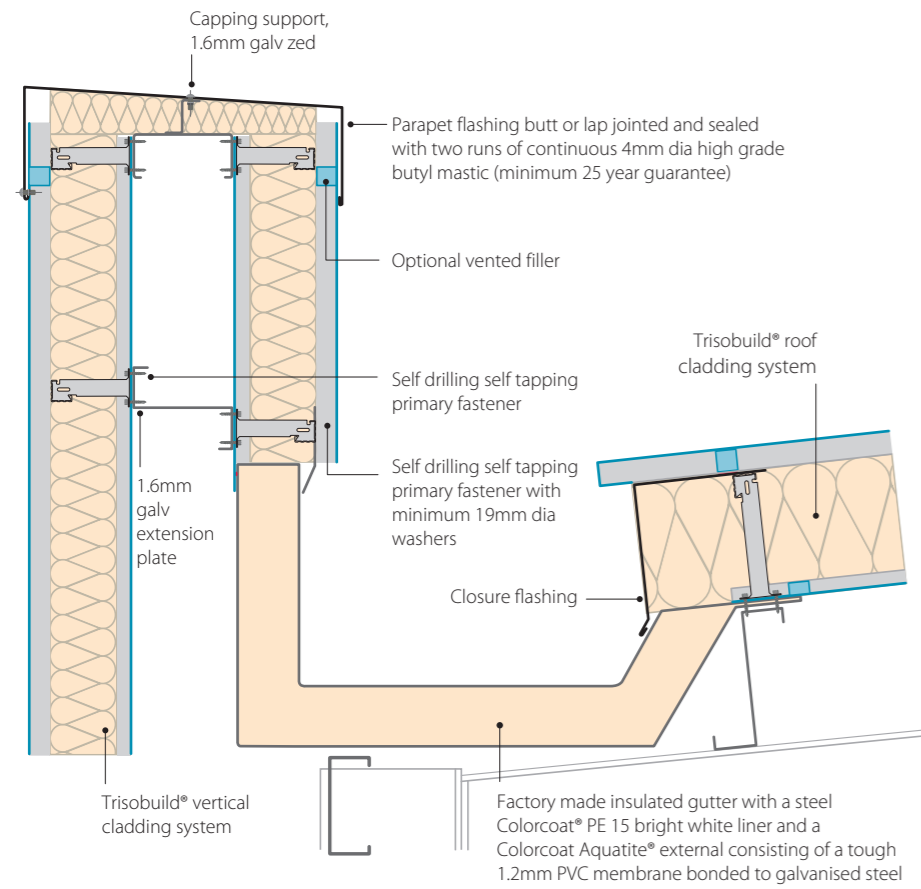

Parapet
The parapet height should be a minimum of 950mm from roof level to be considered as sufficient edge protection as recommended by the HSE.

Psi value (W/mK)	f factor
1.365	0.615

Stated calculation results are dependent on components being as shown. Computer modelled in accordance with EN ISO 10211.

Valley gutter

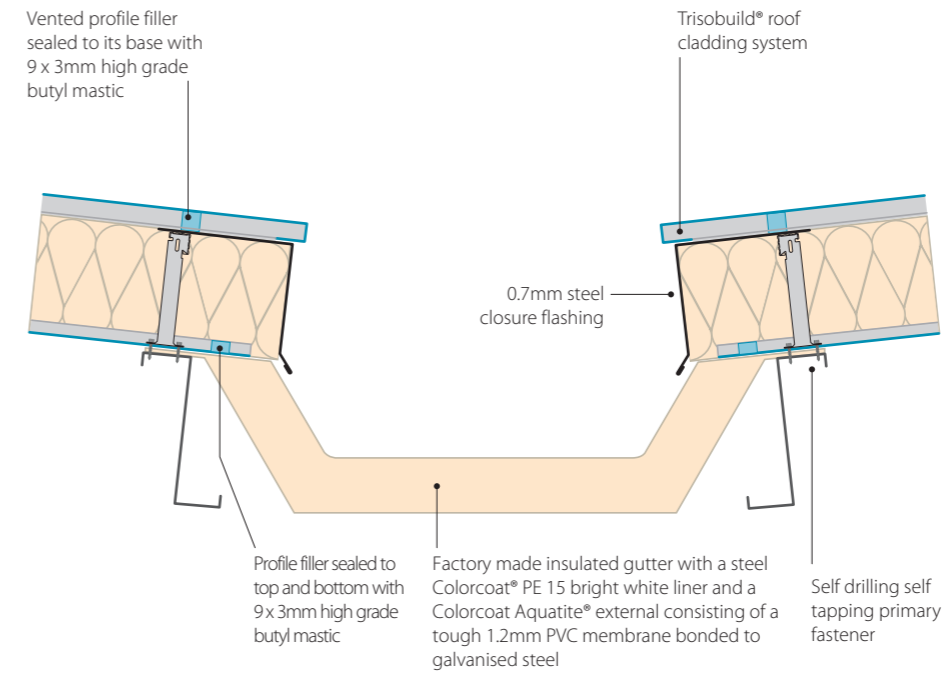

Valley gutter
Ensure a full design is carried out in accordance with BS EN 12056-3:2000 and all manufacturers' recommendations are followed to ensure correct detailing at this important junction.

Psi value (W/mK)	f factor
0.736	0.559

Stated calculation results are dependent on components being as shown. Computer modelled in accordance with EN ISO 10211.

Verge start

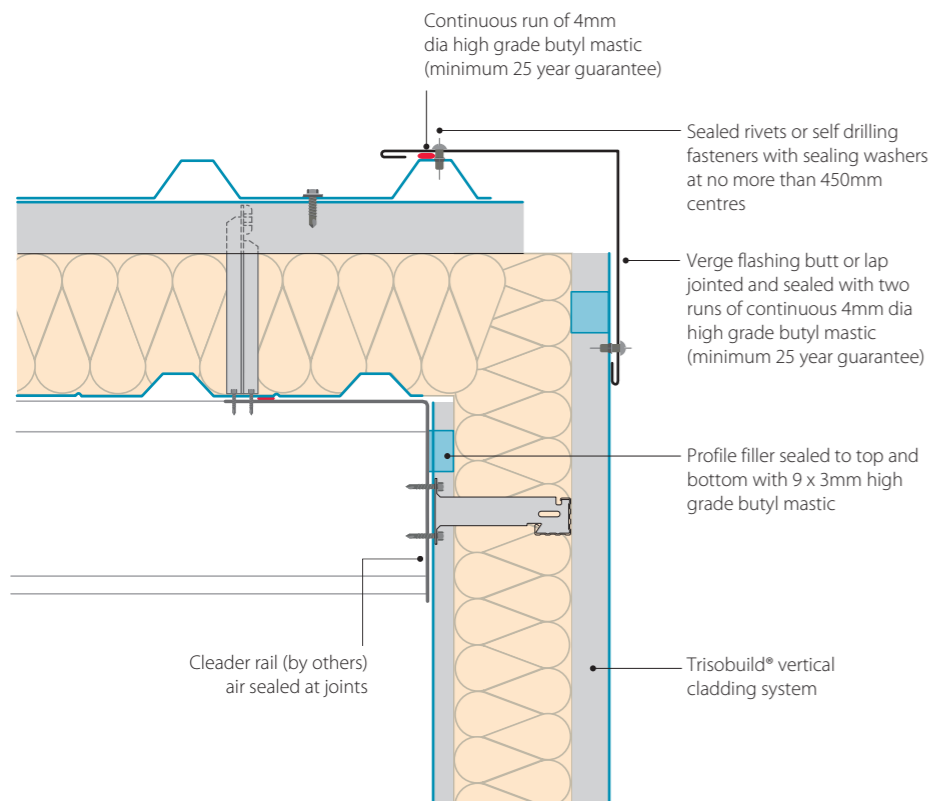

Verge start
It is recommended that single skin flashing has a maximum unsupported leg length of 200mm to maintain the strength for a flat appearance.

Psi value (W/mK)	f factor
0.013	0.96

Stated calculation results are dependent on components being as shown. Computer modelled in accordance with EN ISO 10211.

Standard pipe seal (Dektite)

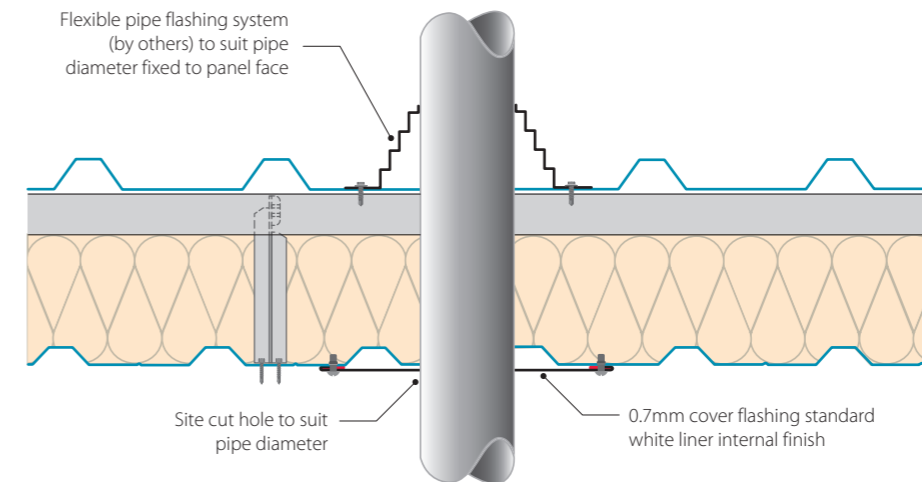

Standard pipe seal and hot pipe seal (Dektite)
The Pipe flashings are available in various specifications to facilitate different opening sizes and temperature ranges. Further details on these specifications and for order placement please contact our Platinum® Plus system guarantee approved suppliers, who are:

SFS intec (T: +44 (0) 113 2085 500)
or EJOT UK Limited
(T: +44 (0) 1977 687040).

Openings encompassing more than one rib of the external profile will require a formed soaker flashing to avoid water entrapment. Holes more than one third of the cover width will also need additional steelwork to provide support.

Construction details – roof continued

Roof light side lap

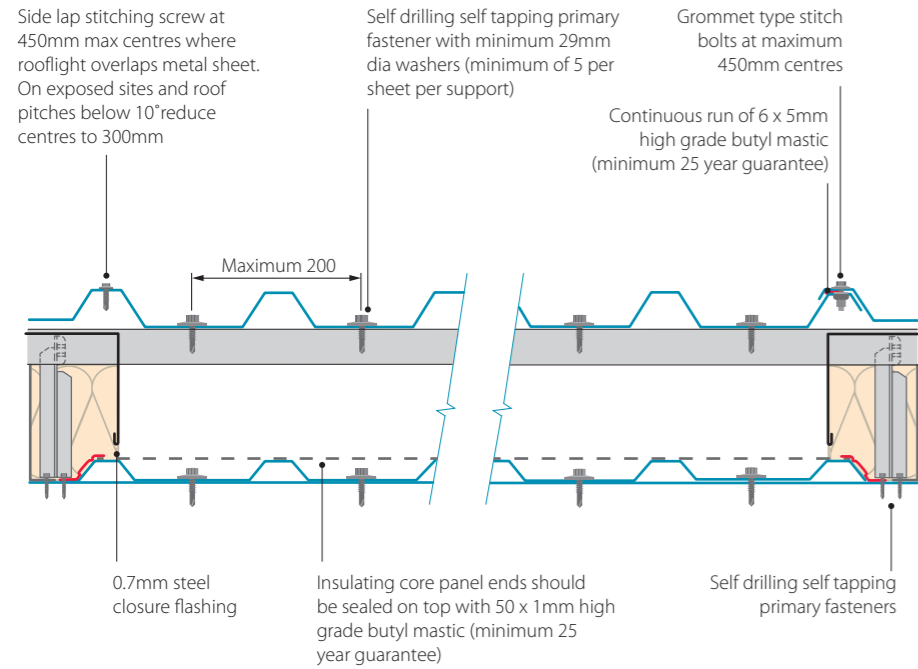

Roof light side lap

In order to achieve a 2.2W/m²K, U-value and comply with the current building regulations for heated buildings a minimum of a triple skin roof light construction should be specified. These triple skin constructions from our approved suppliers (see below for details) provide U-values between 1.9 and 0.9W/m²K.

The roof light liner should be side lapped over the adjacent metal liners on both sides and the side lap joints sealed as shown.

The internal core layer can be laid in place after the liner has been fixed and sealed, and positioned so that it is in contact with the overlapping profile crowns and simply secured with the 50mm film backed butyl tape along each side lap.

Roof light end lap

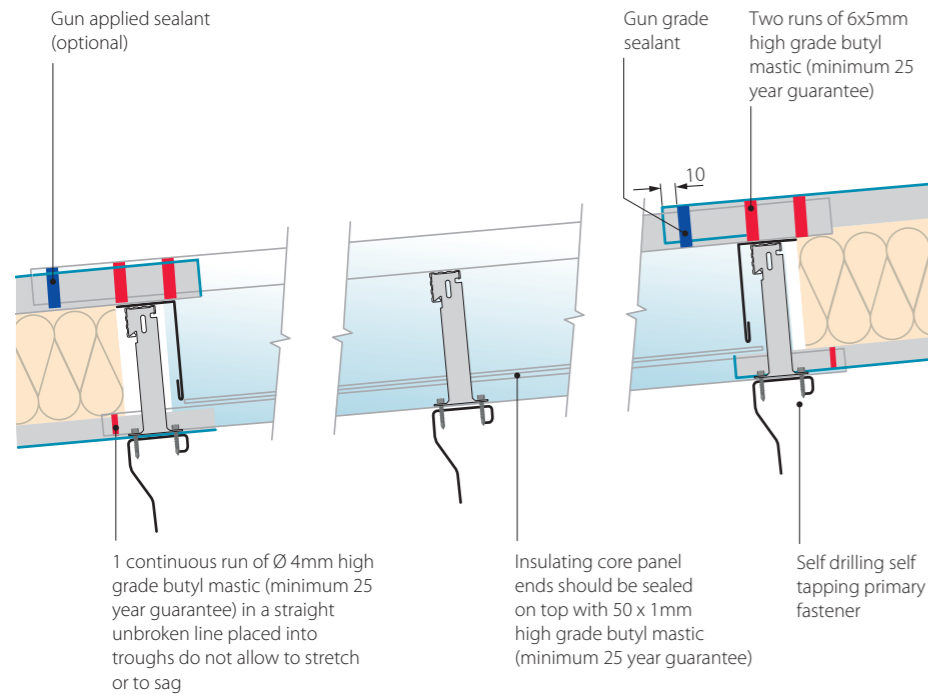

Roof light end lap

Liner end laps should be located directly above a purlin and be a minimum of 100mm. The edges of any sheet in the joint should be minimum of 50mm from the fixing line.

The butyl seals at the end lap position are to be positioned in straight unbroken lines and placed into troughs without allowing the sealant to stretch or sag.

Please refer to manufacturer's information for further details on durability, fragility and fire performance.

Brett Martin Daylight Systems Limited
T: +44 (0) 24 7660 2022
E: daylight@brettmartin.com
www.brettmartin.com

Filon Products Limited
T: +44 (0) 1543 687 300
E: sales@filon.co.uk
www.filon.co.uk

Hambleside Danelaw
T: +44 (0) 1327 701 900
E: sales@hambleside-danelaw.co.uk
www.hamblesidedanelaw.co.uk

Roof to wall junction

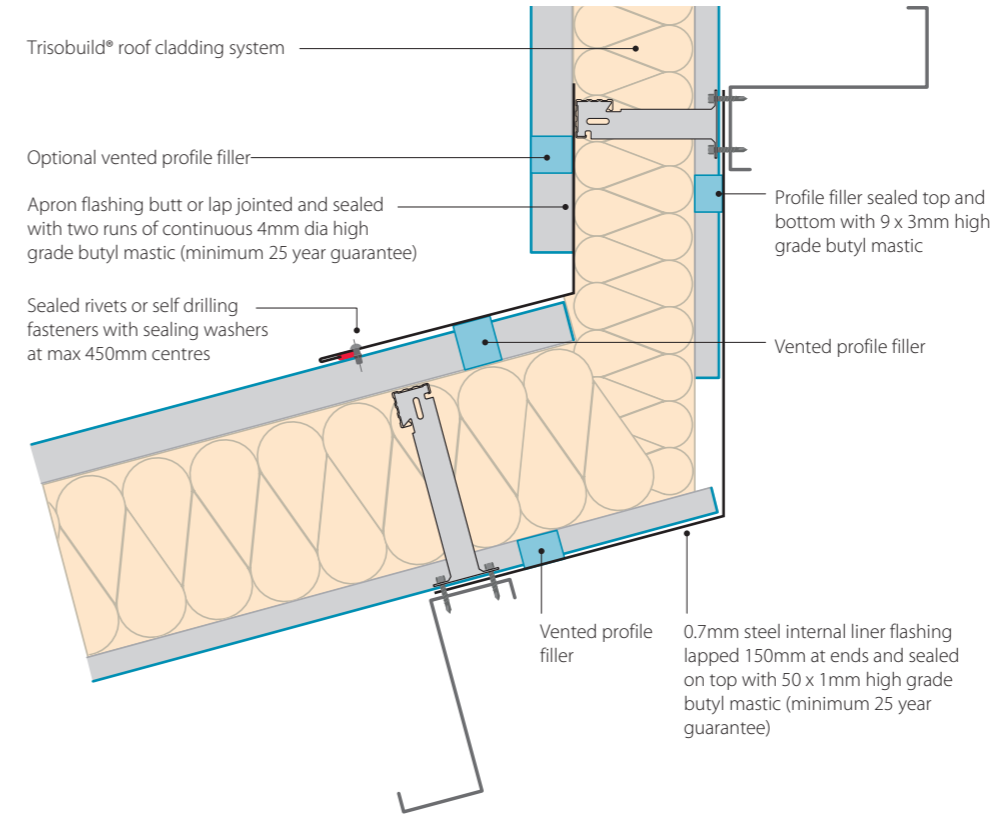

Roof to wall junction

Ensure that the insulation runs continuously between the roof and wall junction to avoid cold bridging so that the low psi and f values shown in the box above are achieved.

Psi value (W/mK)	f factor
0.019	0.975

Stated calculation results are dependant on components being as shown. Computer modelled in accordance with EN ISO 10211.

Roof safety system

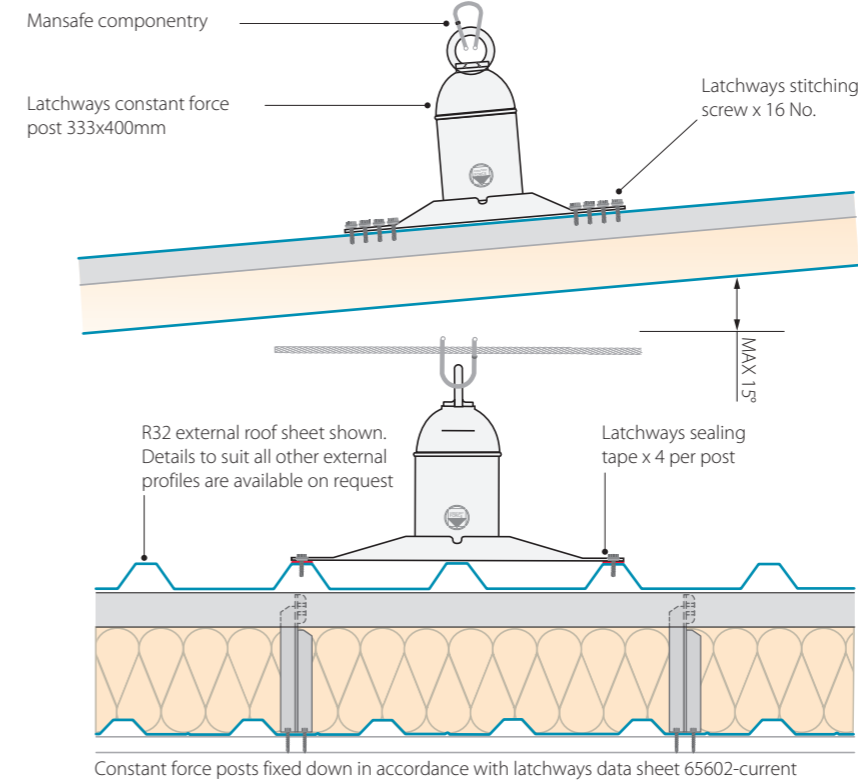

Roof safety system

The detail shown indicates a MSA Latchways system, with the Soter system also available from QBM. These systems will require specialist roof layout design and installation, together with a maintenance and inspection program. Therefore Tata Steel recommend that this specialist advice be obtained from one of two companies below.

MSA Latchways
T: +44 (0) 1380 732700
E: hayley.potter@latchways.com
www.latchways.com

SFS
(Soter™ II Horizontal Lifeline system)
T: +44 (0) 113 2085 500
E: fallprotection@sfs.biz
www.sfsintec.co.uk

Construction details – roof continued

Upstand roof light

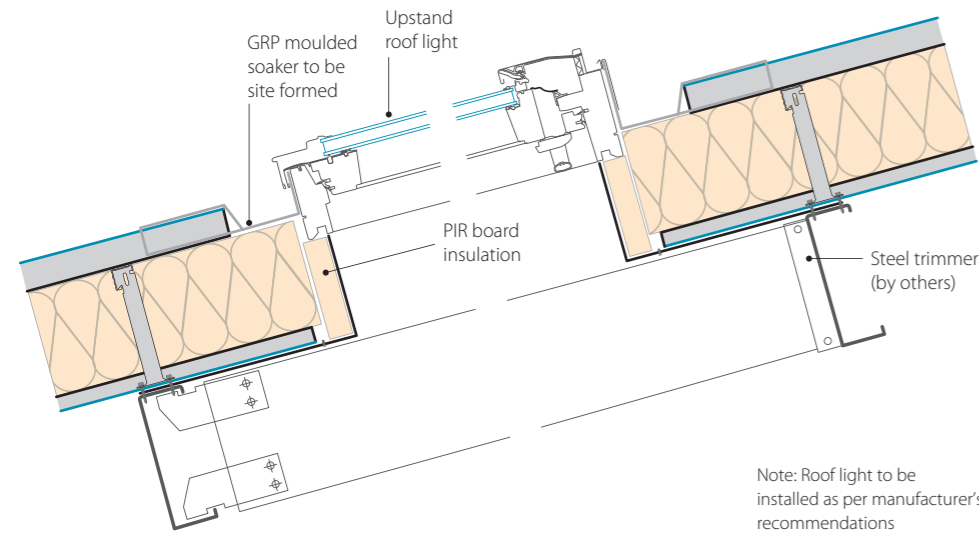

Note: Roof light to be installed as per manufacturer's recommendations

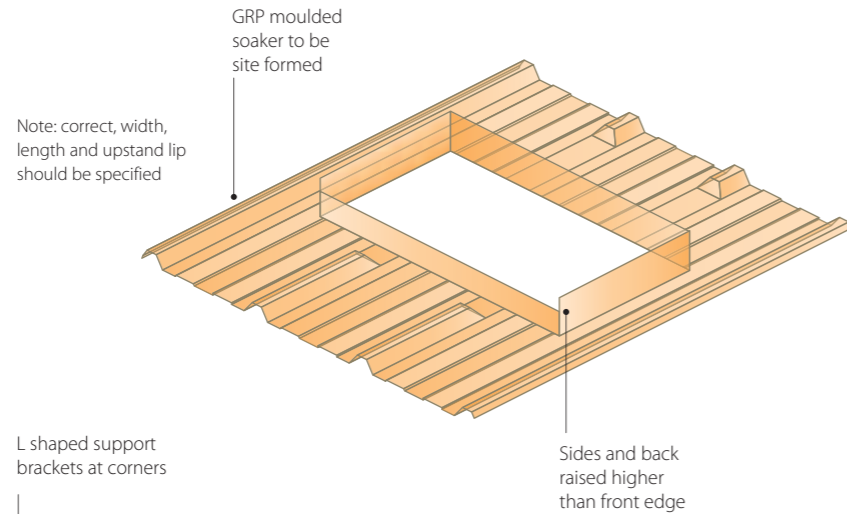

All support steelwork by others

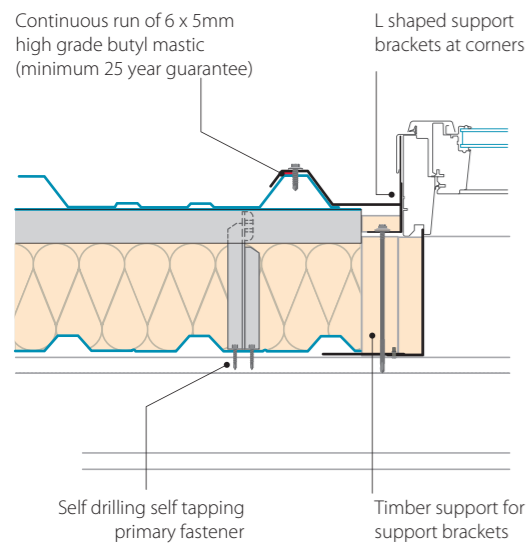

Recommended companies for GRP moulding
 M R Site Services
 Unit 6, Worcester Trading Estate
 Blackpole, Worcester
 Worcestershire, WR3 8HR
 T: +44 (0) 1905 755055
 F: +44 (0) 1905 755053

Jones and Woolman
 Unit 6, Hayes Trading Estate
 Hingley Road, Halesowen
 West Midlands, B63 2RR
 T: +44 (0) 1922 712111
 F: +44 (0) 1922 712539

Fasteners, sealants and fillers

Fastener selection table (15mm washers throughout)

Application	PMJ-tec	EJOT UK	SFS intec
Primary fixing for external profile to spacer bar	SH LS S19 5.5 x 28 PP + colour	CF19-JT3-3-5.5 x 25 + colour	SX3/9-L12-S19-6.0x29 + colour
Primary fixing for internal liner profile to cold rolled purlins	SH LS S16 5.5 x 25	JT3-3-5.5 x 25 S16	SX3/9-S16-6.0x29
Primary fixing for internal liner profile to hot rolled purlins	SH HS S16 5.5 x 40	JT3-12-5.5 x 40 S16	SX14/12-S16-5.5x40
Primary fixing for spacer bracket to cold rolled purlins	SH LS S16 5.5 x 28	JT3-3-5.5 x 35 S16	SX3/9-S16-6.0x29
Primary fixing for spacer bracket to hot rolled purlins	SH HS S16 5.5 x 40	JT3-12-5.5 x 40 S16	SX14/12-S16-5.5x40
External stitching screw for side-lap and/or metal flashing to external weathering profile	SH ST S16 5.5 x 22 PP + colour	CF15-JT3-2-5.5 x 25 + colour	SL2-S-L12-S16-6.3x28 + colour
External rivet for side-lap and/or metal flashing to external weathering profile	RIV 0619 PP + colour	ALV 4.8 x 15 aluminium rivet (state colour required)	Polygrip-ASO-D-48100 + colour

When fixing to timber, fastener pullout values may limit the ability of the roof to resist wind uplift loads. If in doubt, consult the Technical Department. All fasteners can be sourced from SFS intec (T: +44 (0) 113 2085 500), PMJ-tec (T: +44 (0) 1451 822777), or EJOT UK Limited (T: +44 (0) 1977 687040).

Sealants and fillers

The end laps of the external weathering profile of the Trisobuild® systems require two rows of 6x5mm high grade butyl mastic (minimum 25 year guarantee) this generally comes in rolls of 9.6m with 30 rolls per box. Position sealant in straight, unbroken lines, following the profile, taking care to avoid any stretch. Ensure the continuity and the effectiveness of the seal, especially at corners of sheets. The two lines of strip sealant must be placed between the sheets before fixing: one row nominally 10mm from both the sheet ends at the top and bottom of the lap.

The side laps of the external weathering profile should also be sealed with a 6 x 5mm high grade butyl mastic (minimum 25 year guarantee), placed between sheets on the weather side of the under lap crown.

For external weathering black EPDM, MP or Superseal vented profile fillers should be located between the external profile and the cover flashing (ie, ridge and hip positions) to provide continuity of weather seal and to prevent access by insects and small birds. These shaped fillers should be sealed to their base with a run of gun-applied solvent-release sealant.

The liner profile should have both the side and end laps sealed. The end laps sealed with a 4mm diameter high grade butyl mastic (minimum 25 year guarantee).

The side lap sealed with a 50 x 1mm high grade butyl mastic (minimum 25 year guarantee) positioned on top of joint.

For liner profile ends at ridges and hips, white EPDM, MP or Superseal small-flute-profile fillers should be located between the profile's internal profile and the internal cover flashing to provide continuity of air seal. These fillers should also be sealed top and bottom on a run of gun-applied solvent-release sealant.

All sealants can be sourced from either:
 Premier Sealants (White strip),
 T: +44 (0) 1724 864100
 EJOT UK Limited (Blue Strip).
 T: +44 (0) 1977 687040
 SFS intec Ltd, (Pink Strip).
 T: +44 (0) 113 208 5500
 Brett Martin (Green strip),
 T: +44 (0) 24 7660 2022

All fillers can be sourced from either:
 Premier Sealants, T: +44 (0) 1724 864100
 EJOT UK Limited, T: +44 (0) 1977 687040
 Brett Martin, T: +44 (0) 24 7660 2022

Typical fastener layouts

The table opposite shows typical fastener layouts for roof profiles. More fasteners may need to be included to resist negative wind load forces. It is recommended that you speak to our Technical Department to discuss the specific loading and support structure on your project to ensure that sufficient restraint is being provided.

T: +44 (0) 1244 892199
 E: technical.envelopeproducts@tatasteelurope.com

Profile	Main fixings (sheet ends)	Main fixings (intermediate)	Side lap fixing
13½/3	Every third trough	Every third trough	450mm centres (1½ laps)
R32	Every other trough (5 No.)	Every other trough (3 No.)	450mm centres
R35	Every other trough (6 No.)	Every other trough (4 No.)	450mm centres
R46	Every trough	Every trough	450mm centres

Fasteners, sealants and fillers

External End Lap

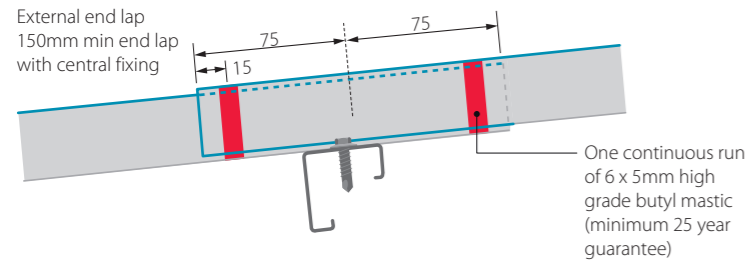

Internal End Lap

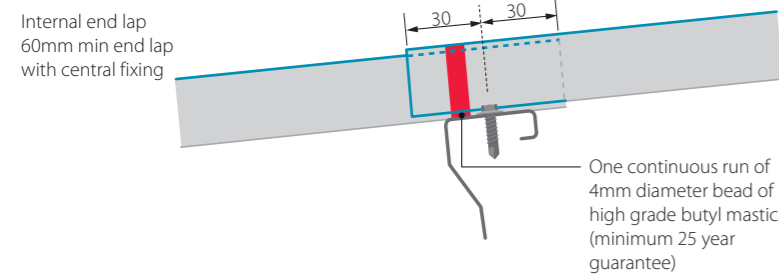

External Side Lap

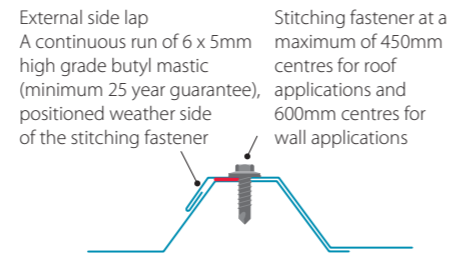

Internal Side Lap

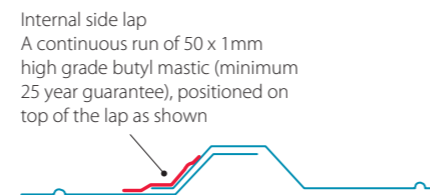

Vertical wall installation

The steps given below are instructions for a typical construction and should be used only as a guide. Specific technical details, method statements and site-specific risk assessments should be produced and applied for each building. An extended list of construction details is available from Tata Steel, and advice can be given via our Technical Department on any bespoke details that may be required.

Firstly checks should be carried out to make sure that all rails are adequately supported and level along their full length, before commencing installation work. If this is satisfactory, carry out preparation work on cill trims and internal corner flashing etc. and ensure these are lined, levelled and sealed as specified.

Install the liner sheets in tiers over part or all of the elevation, ensuring alignment and cover is maintained. Seal liner laps as shown on page 46.

Lie out the Instaloc® Plus spacer system on the floor using 3m or 3.6m bars and ensure brackets are positioned at specified centres and adjacent to liner troughs. Install the Instaloc® Plus spacer system along the rail line ensuring level is maintained.

The insulation and external sheet should be laid in sequence from one corner of the building elevation so that wherever possible the exposed joints of the side laps are away from the prevailing wind. The sheeting should be installed in the sequence shown below.

Before installing the insulation, 'stick pins' should be positioned to the liner face at mid span, and then the insulation should be draped from the eaves and tucked behind the horizontal spacer system and over the 'stick pins' so that it is held in place. Each tier of insulation should be compressed tightly with the previously one to make certain there are no gaps. If there are two layers of insulation; the joints in each layer should be offset.

The end and side laps of the external sheet should be sealed as specified on page 46. Advice should be obtained from our Technical Department on fastener frequency, as this will depend on the calculated wind load for the cladding.

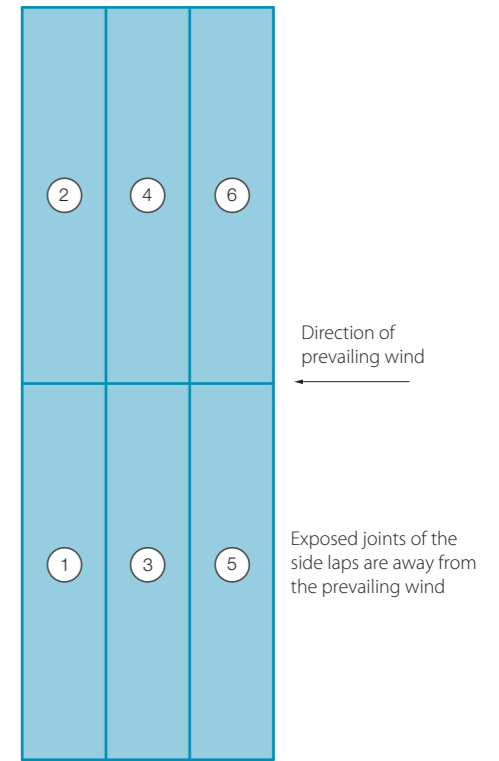

Trisobuild® VW vertical wall system

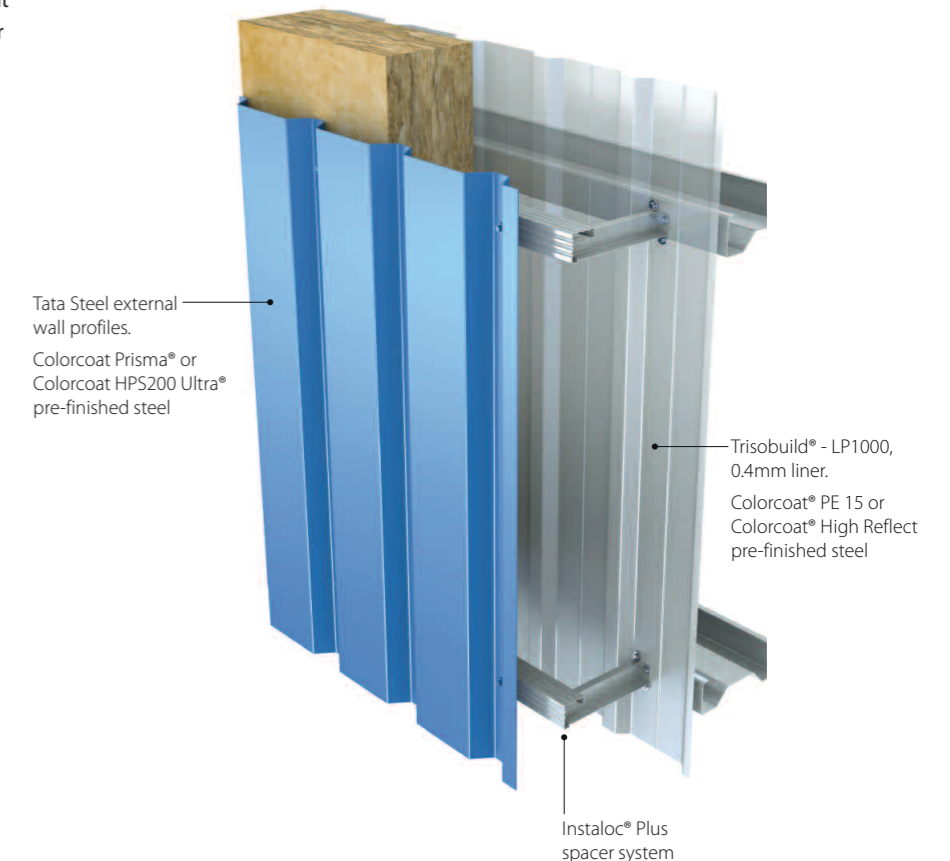

Help with specification creation:

For information and help on creating your Platinum® Plus tailored specification please contact:
T: +44 (0) 1244 892199
E: technical.envelopeproducts@tatasteel.com
www.tatasteelconstruction.com/speccreator

Construction details – wall

Vertical details

The details within this section are recommendations and have been designed to give practical solutions to minimise thermal bridging and air loss at junctions. For each relevant junction detail, Ψ values (psi) and f values have been calculated in accordance with BS EN ISO 10211.

All support steelwork by others.

External corner

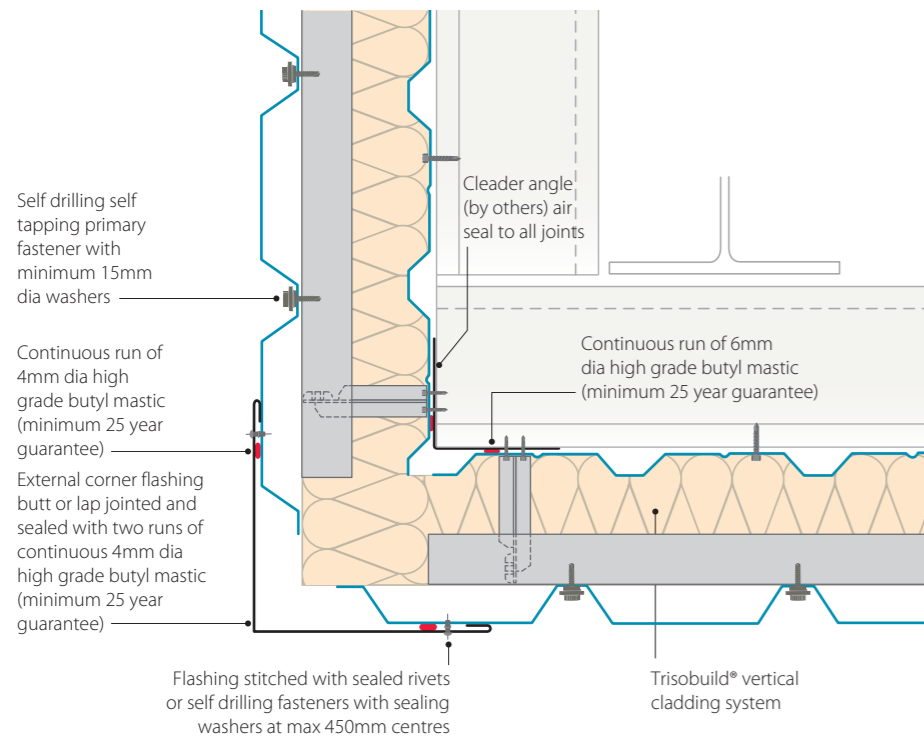

External corner
Ensure that cleader angle is jointed and sealed so that the seal to the liner sheet maintains the air tightness of the detail along its length. Also give attention to the sealing arrangement at the top and bottom of the corner to ensure the continuity of the air tightness around these junctions.

Psi value (W/mK)	f factor
0.016	0.96

Stated calculation results are dependent on components being as shown. Computer modelled in accordance with EN ISO 10211.

Drip detail base

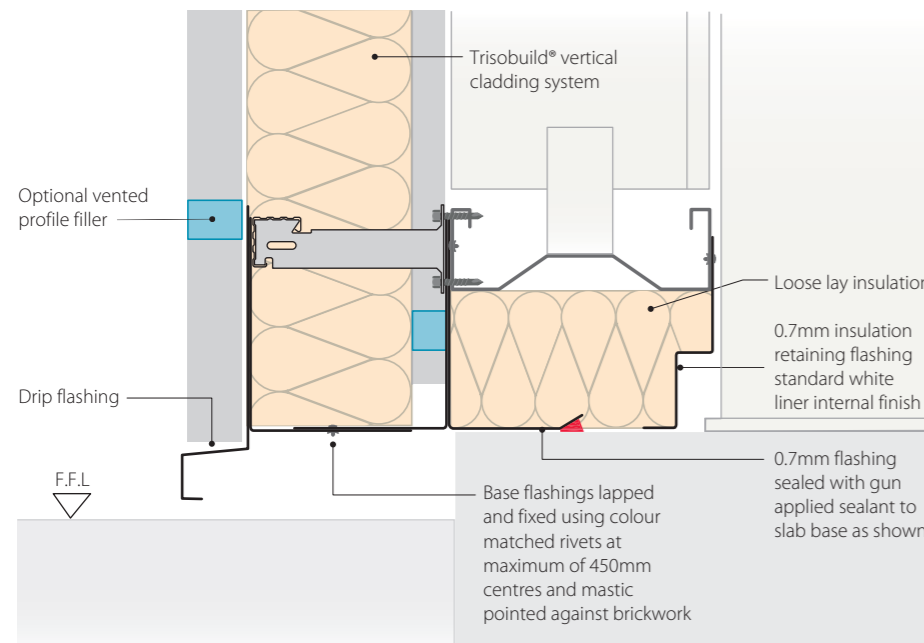

Drip detail base
Loose laid mineral fibre quilt insulation is used below bottom cladding rail to reduce cold bridging at slab base.

Psi value (W/mK)	f factor
0.198	0.81

Stated calculation results are dependent on components being as shown. Computer modelled in accordance with EN ISO 10211.

Internal corner

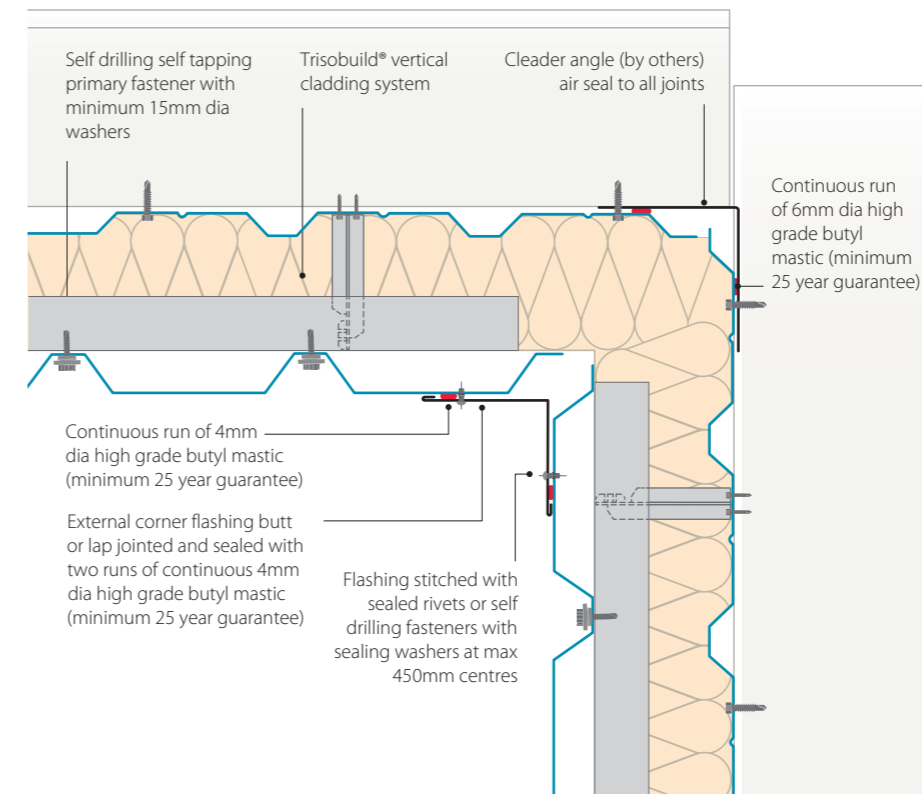

Internal corner
Ensure that the insulation runs continuously around the corner junction to avoid cold bridging so that the low psi and f values shown in the box above and below are achieved.

Psi value (W/mK)	f factor
0.010	0.94

Stated calculation results are dependent on components being as shown. Computer modelled in accordance with EN ISO 10211.

Drip detail dado wall

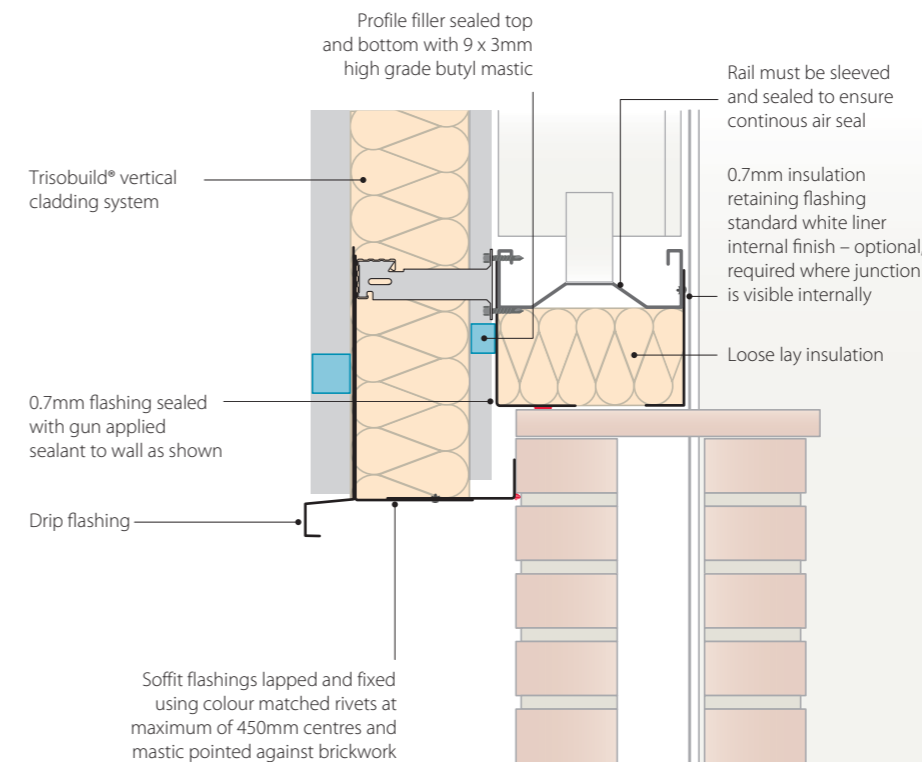

Drip detail dado wall
Loose laid mineral fibre quilt insulation is used below bottom cladding rail to reduce cold bridging at the top of the dado wall.

Psi value (W/mK)	f factor
0.42	0.75

Stated calculation results are dependent on components being as shown. Computer modelled in accordance with EN ISO 10211.

Construction details – wall

Vertical details continued

Window head/sill

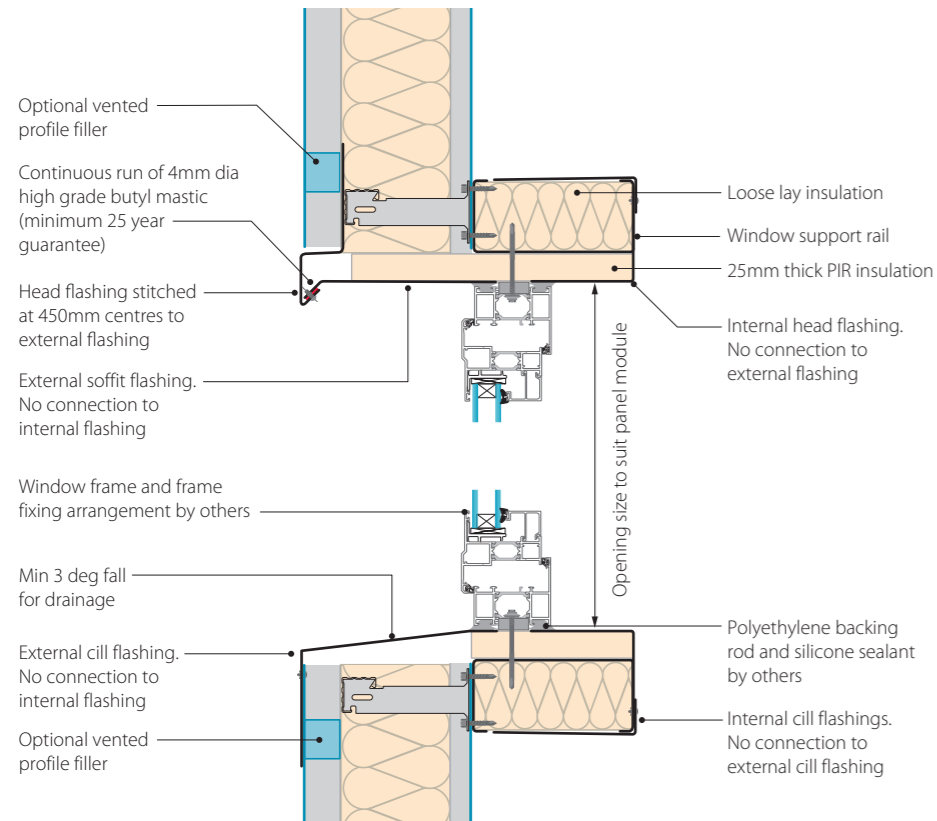

Window head/sill
This window flashing detail has been designed so that it can accommodate any proprietary window. The window should be installed as per manufacturer's recommendations.

Window head

Psi value (W/mK)	f factor
0.070	0.96

Stated calculation results are dependent on components being as shown. Computer modelled in accordance with EN ISO 10211.

Window sill

Psi value (W/mK)	f factor
0.030	0.96

Stated calculation results are dependent on components being as shown. Computer modelled in accordance with EN ISO 10211.

Window jamb

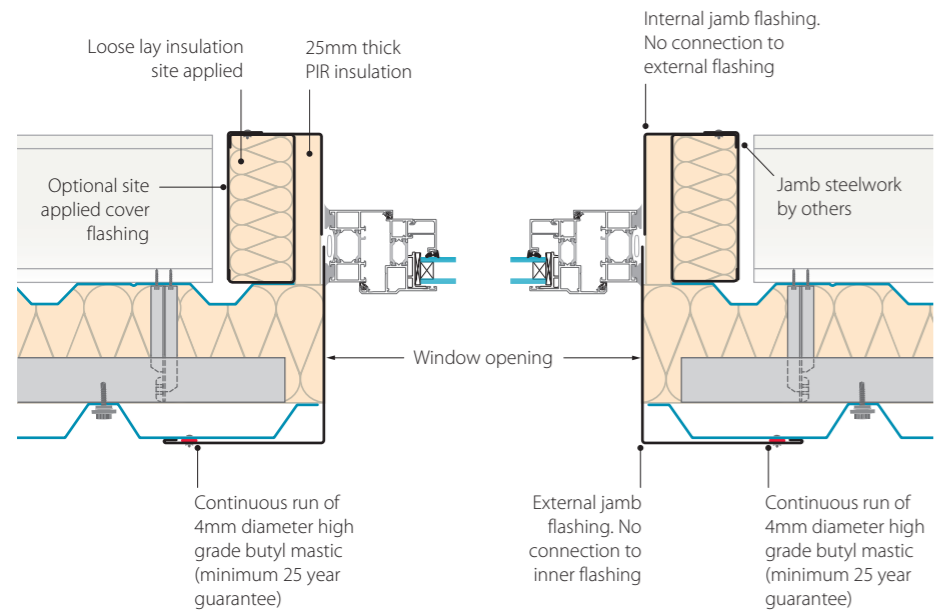

Window jamb
Trimming steelwork around the opening is required to support the window independent to the panels.

Psi value (W/mK)	f factor
0.030	0.96

Stated calculation results are dependent on components being as shown. Computer modelled in accordance with EN ISO 10211.

Vertical to horizontal break

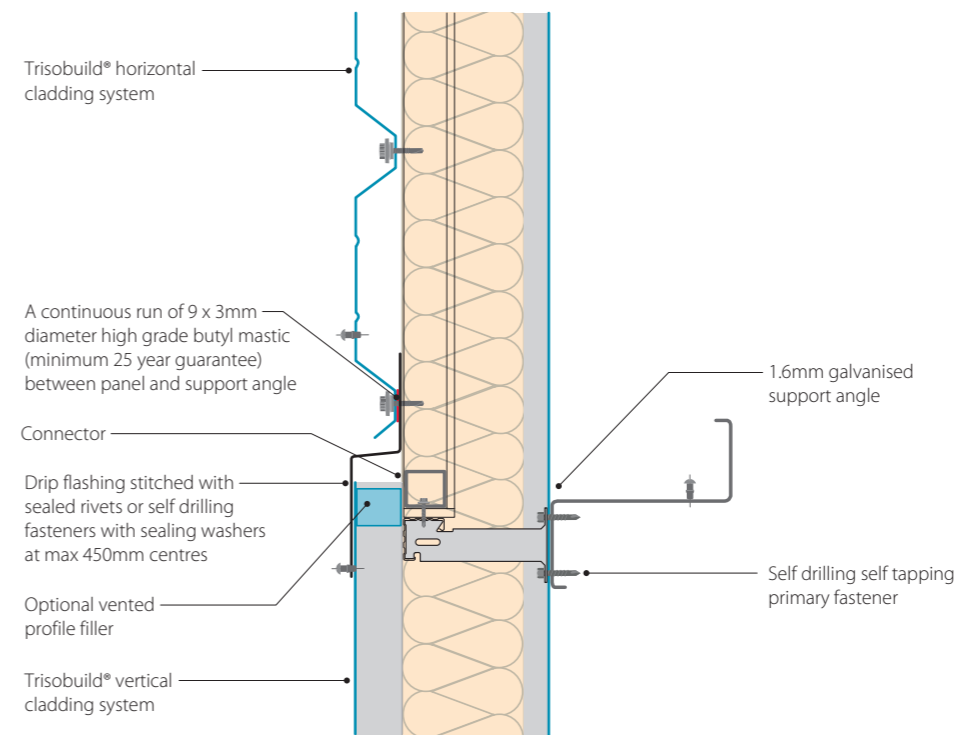

Vertical to horizontal break
Horizontal and vertical profiles can be installed adjacent to each other creating interesting architectural features, while the drip flashing detail still maintains thermal performance and an efficient weather seal.

Brick wall abutment

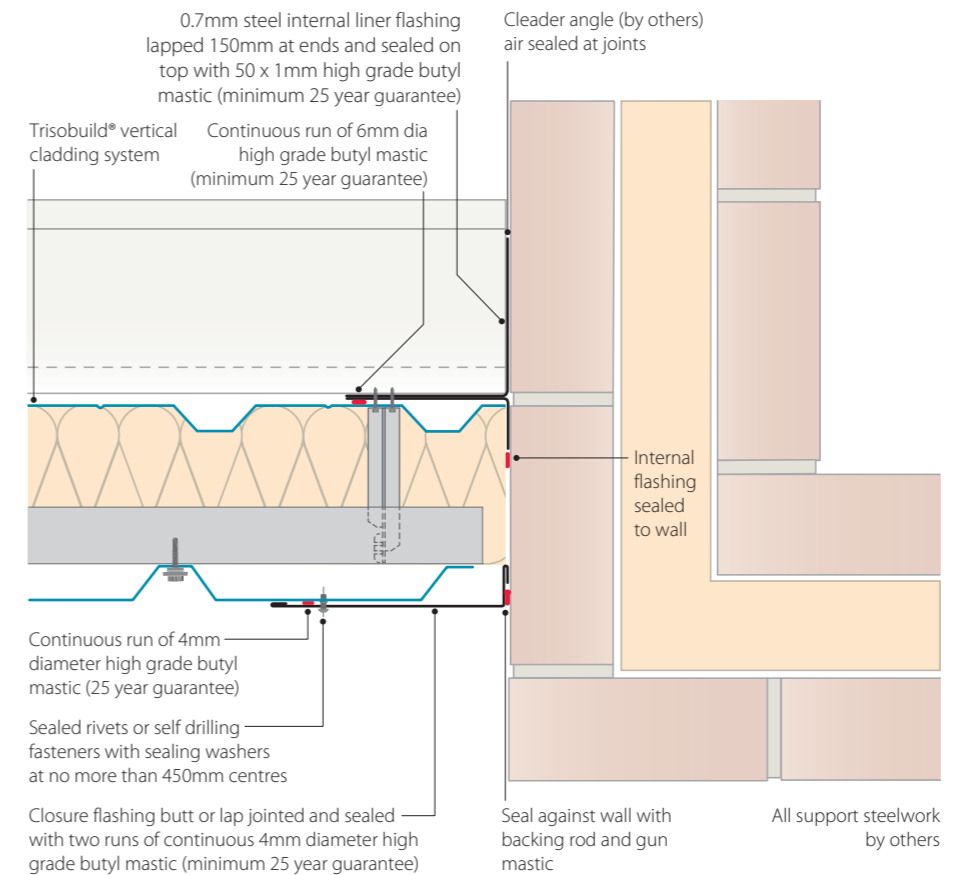

Brick wall abutment
Masonry fasteners to be stainless steel to maintain the durability of the system.

Psi value (W/mK)	f factor
0.010	0.94

Stated calculation results are dependent on components being as shown. Computer modelled in accordance with EN ISO 10211.

Horizontal wall installation

The following guidance assumes a regular horizontal cladding rail arrangement with a vertical liner and vertical Platinum® Plus approved spacer system. The steps given below are instructions for a typical construction and should be used only as a guide. Specific technical details, method statements and site-specific risk assessments should be produced and applied for each building. An extended list of construction details is available from Tata Steel, and advice can be given via our Technical Department on any bespoke details that may be required.

Firstly checks should be carried out to make sure that the base rail is adequately supported and level along its full length and that the flanges of all rails are within the specified vertical datum tolerance. If satisfactory carry out preparation work on cill trims and internal corner flashing etc. and ensure these are lined, levelled and sealed as specified.

Install vertical liner in tiers over part or all of the elevation, ensuring alignment and cover is maintained. Seal liner laps as shown on page 46.

To start the installation of the spacer system, an Instaloc® Plus spacer should be installed horizontally, following the base rail. Lie out the spacer system on the floor using 3m bars and ensure brackets are positioned at specified centres and adjacent to liner troughs. Install the Instaloc® Plus spacer system along the bottom rail line ensuring level is maintained.

Next install the vertical system by positioning the spacer brackets at secondary rail positions and linking the vertical bar into the Instaloc® Plus base rail using the supplied connectors.

The insulation and external sheet should be laid in sequence from the base of the elevation to the eaves in rows the full length

Help with specification creation:
For information and help on creating your Platinum® Plus tailored specification please contact:
T: +44 (0) 1244 892199
E: technical.envelopeproducts@tatasteeleurope.com
www.tatasteelconstruction.com/speccreator

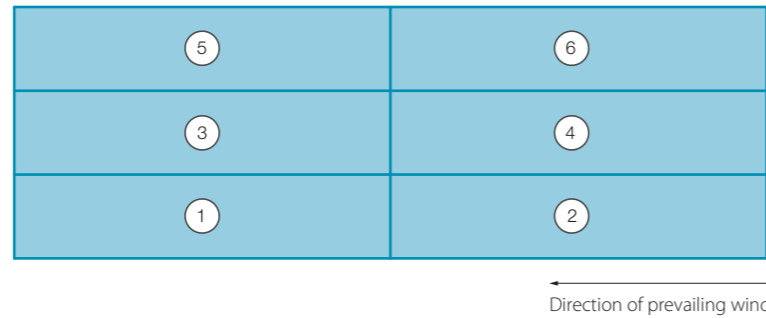

of the elevation. This sequence will ensure the correct lapping arrangement and maintain profile alignment. When 3 metres off floor level it may be more efficient to continue in tiers with a platform lift, if this is preferred, make sure subsequent tiers are aligned and top corner of the sheet is lapped correctly with previous tier (ie as if you were cladding in rows).

Before installing the insulation, 'stick pins' should be positioned to the liner face at mid span between vertical rails, and then the insulation should be run horizontally and tucked behind the vertical spacer system and over the 'stick pins' so that it is held in place.

Trisobuild® HW horizontal wall system

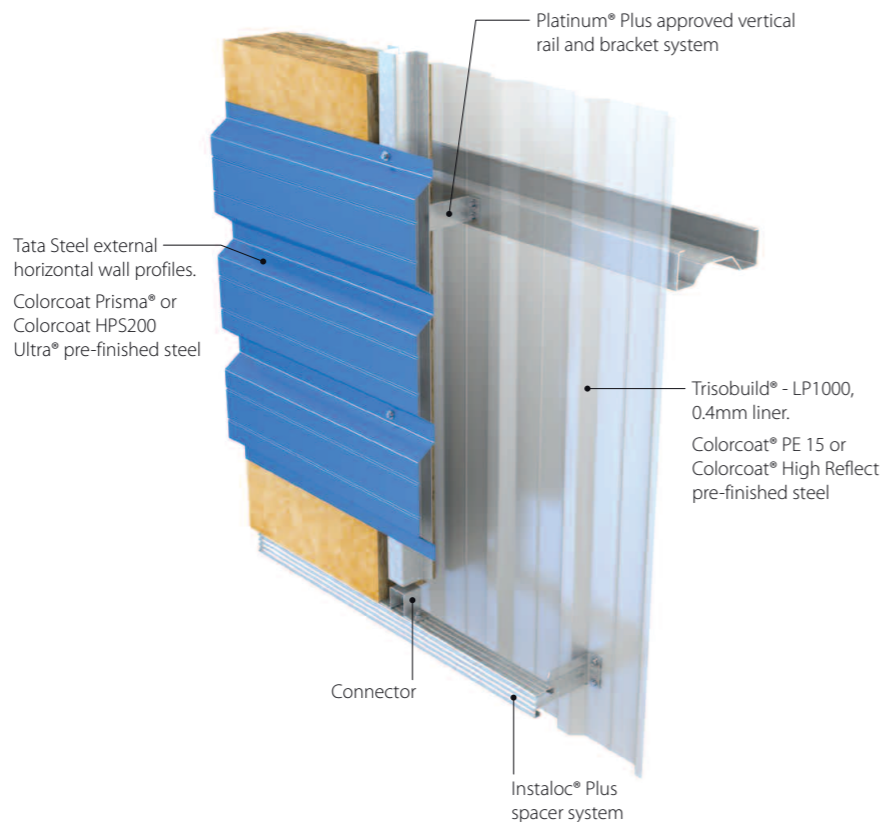

Each row of insulation should be compressed tightly with the previously row to make certain there are no gaps. If there are two layers of insulation; the joints in each layer should be offset.

The end and side laps of the external sheet should be sealed as specified on page 46. Advice should be obtained from our Technical Department on fastener frequency, as this will depend on the calculated wind load for the cladding.

The contractor should ensure that any swarf or debris that have fallen onto the ledges of the profile ribs are removed on final inspection.

Construction details – wall

Horizontal details

External corner

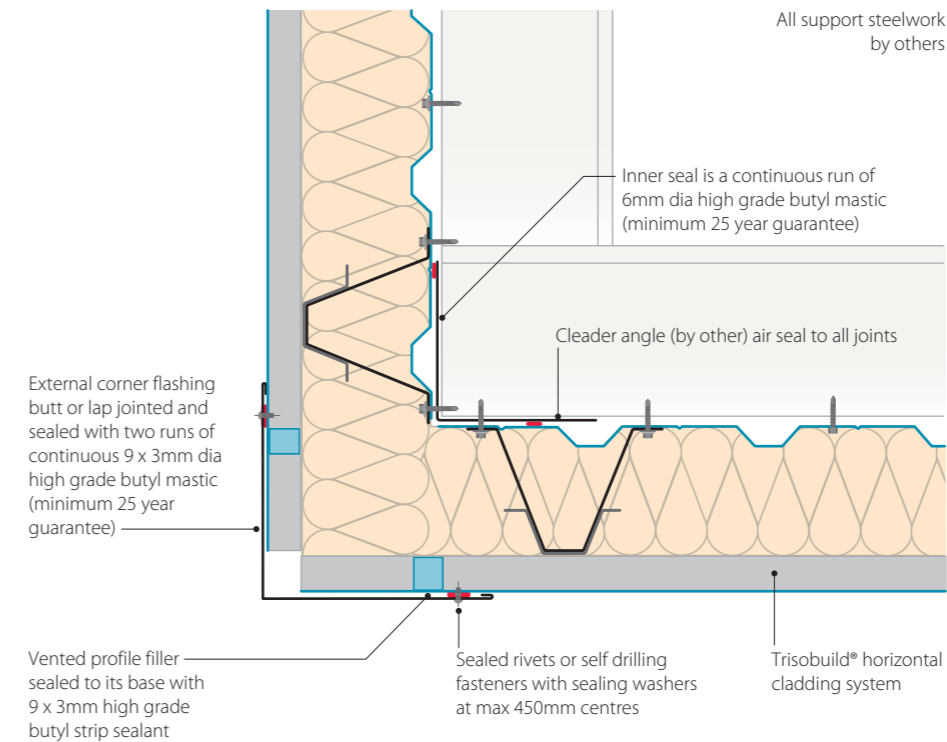

External corner
Ensure that cleader angle is jointed and sealed so that the seal to the liner sheet maintains the air tightness of the detail along its length. Also give attention to the sealing arrangement at the top and bottom of the corner to ensure the continuity of the air tightness around these junctions.

Psi value (W/mK)	f factor
0.016	0.96

Stated calculation results are dependent on components being as shown. Computer modelled in accordance with EN ISO 10211.

Internal corner

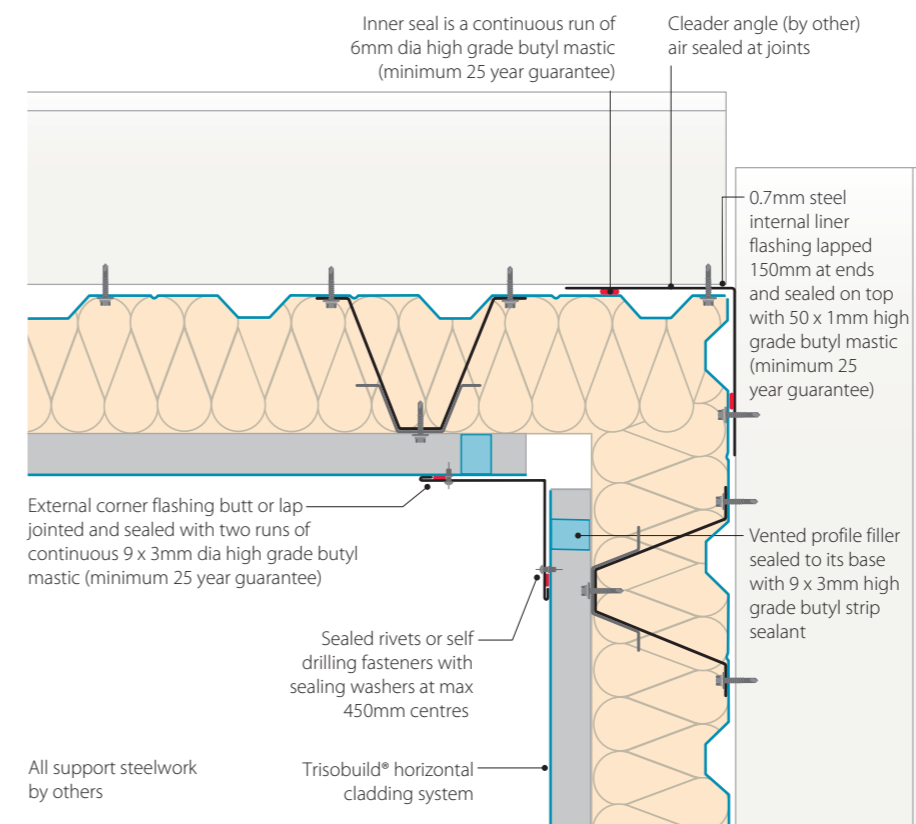

Internal corner
In addition and also related to the above detail, ensure that the insulation runs continuously around the corner junction to avoid cold bridging so that the low psi and f values shown in the box above and below are achieved.

Psi value (W/mK)	f factor
0.002	0.975

Stated calculation results are dependent on components being as shown. Computer modelled in accordance with EN ISO 10211.

Construction details – wall

Horizontal details continued

Slab base drip

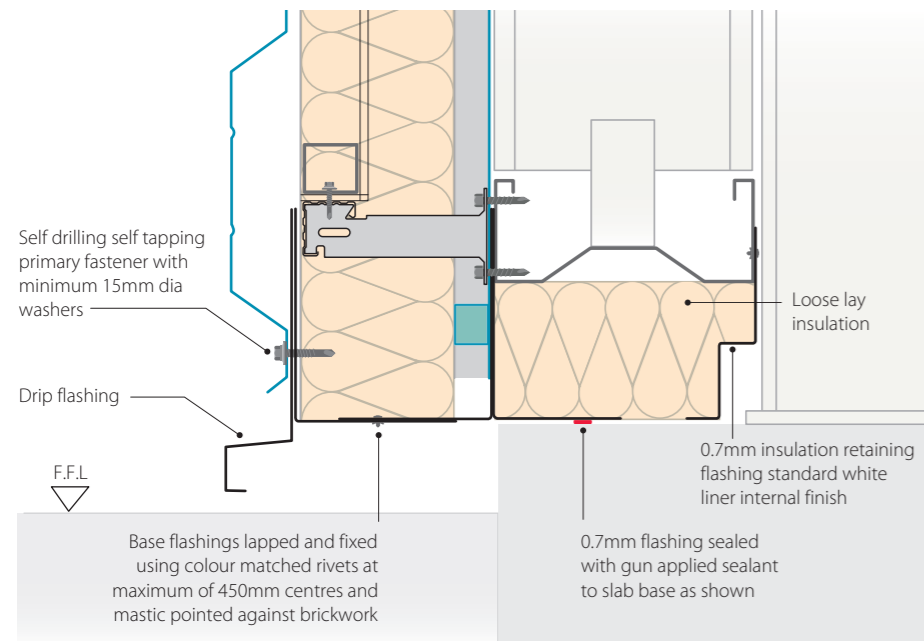

Slab base drip
Loose laid mineral fibre quilt insulation is used below bottom cladding rail to reduce cold bridging at slab base.

Psi value (W/mK)	f factor
0.210	0.95

Stated calculation results are dependent on components being as shown. Computer modelled in accordance with EN ISO 10211.

Window/door head

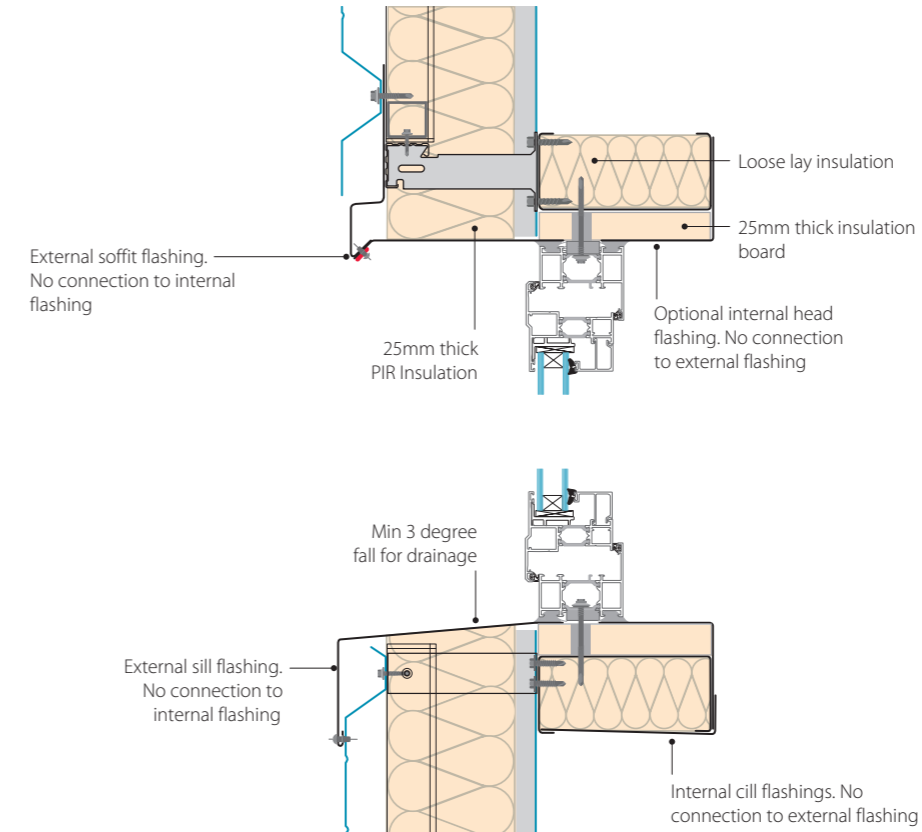

Window/door head
This window flashing detail has been designed so that it can accommodate any proprietary window. The window should be installed as per manufacturer's recommendations.

Psi value (W/mK)	f factor
0.070	0.580

Stated calculation results are dependent on components being as shown. Computer modelled in accordance with EN ISO 10211.

Window sill

Psi value (W/mK)	f factor
0.580	0.960

Stated calculation results are dependent on components being as shown. Computer modelled in accordance with EN ISO 10211.

Dado wall drip

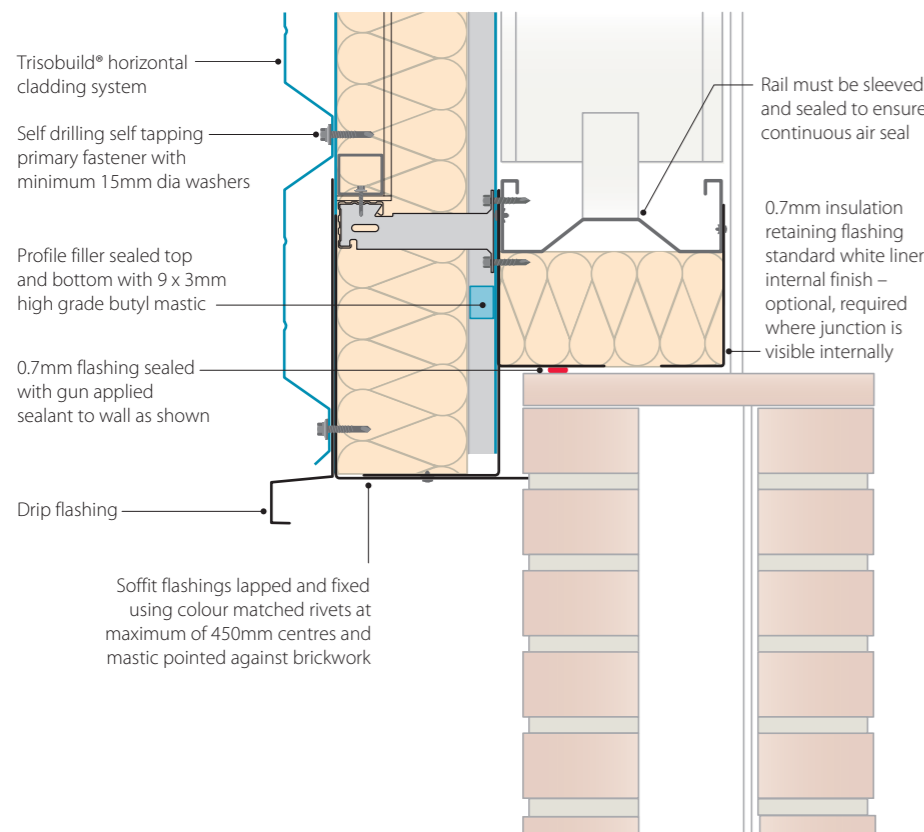

Dado wall drip
Loose laid mineral fibre quilt insulation is used below bottom cladding rail to reduce cold bridging at the top of the dado wall.

Psi value (W/mK)	f factor
0.210	0.95

Stated calculation results are dependent on components being as shown. Computer modelled in accordance with EN ISO 10211.

Window/door jamb

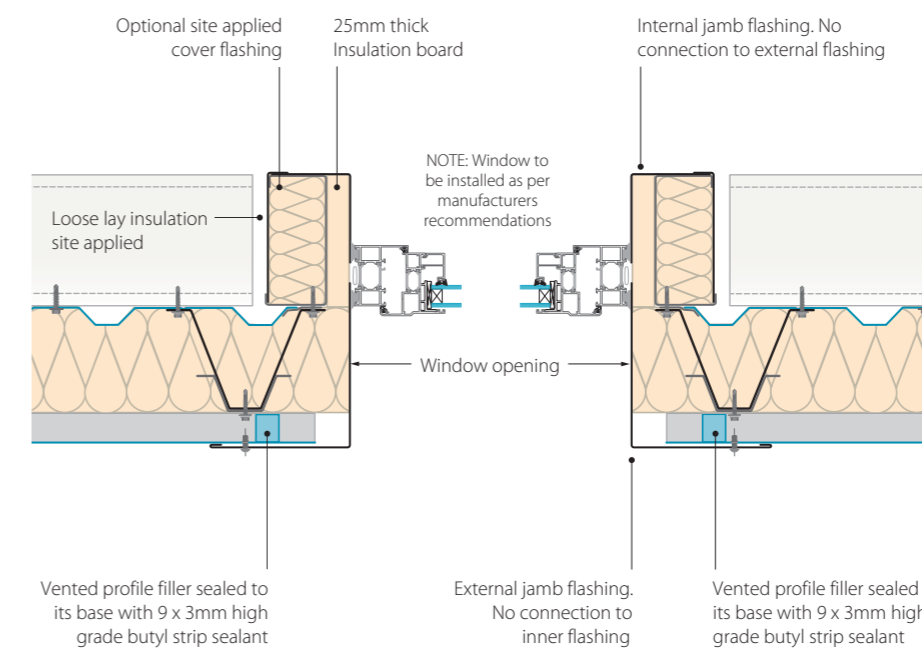

Window/door jamb
Trimming steelwork around the opening is required to support the window or door independent to the panels.

Construction details – wall Horizontal details continued

Horizontal to vertical break

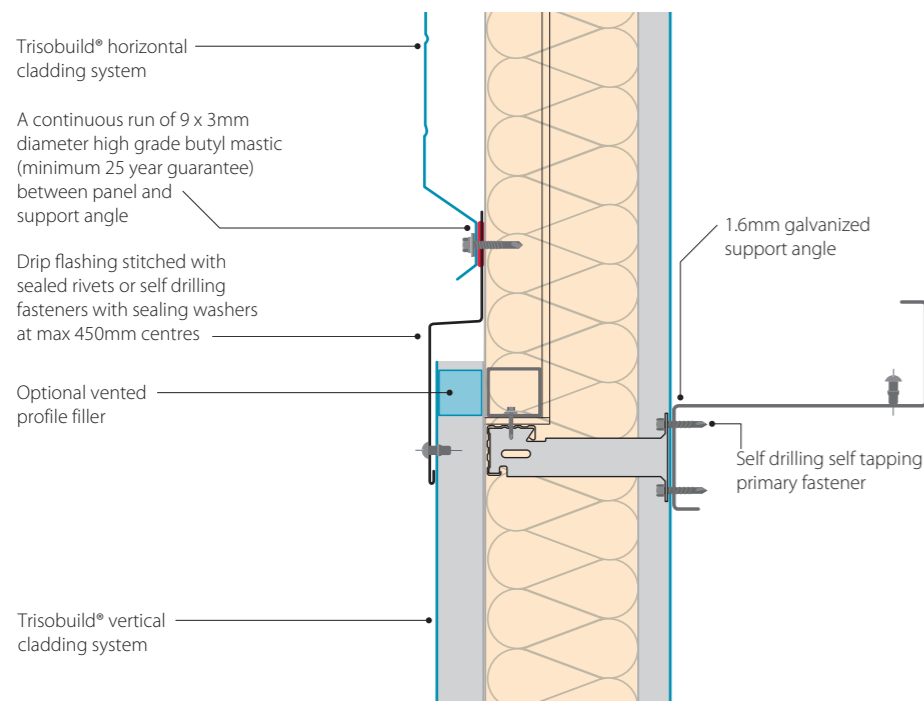

Horizontal to vertical break
Horizontal and vertical profiles can be installed adjacent to each other creating interesting architectural features, while the drip flashing detail still maintains thermal performance and an efficient weather seal.

Psi value (W/mK)	f factor
1.103	0.579

Stated calculation results are dependent on components being as shown. Computer modelled in accordance with EN ISO 10211.

Brick wall abutment

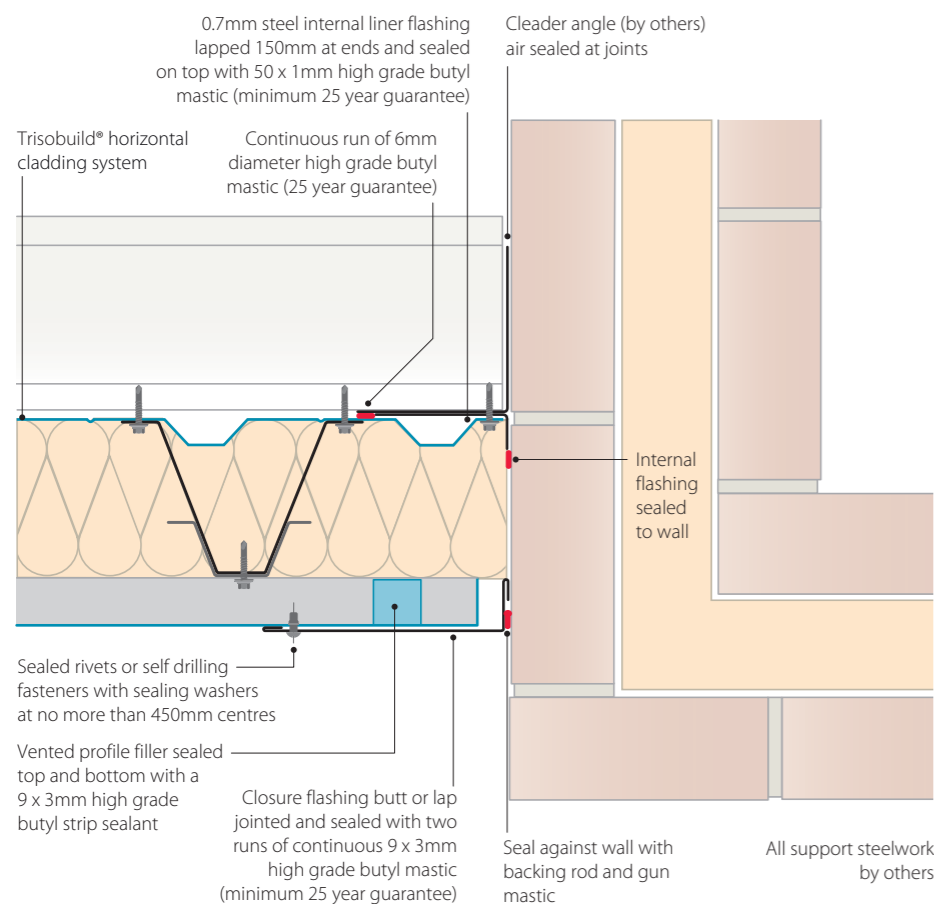

Brick wall abutment
Masonry fasteners to be stainless steel to maintain the durability of the system.

Psi value (W/mK)	f factor
0.010	0.940

Stated calculation results are dependent on components being as shown. Computer modelled in accordance with EN ISO 10211.

Fasteners, sealants and fillers

Fastener selection table (15mm washers throughout)

Application	PMJ-tec	EJOT UK	SFS intec
Primary fixing for external profile to spacer bar	SH LS S16 5.5 x 28 PP + colour	CF15-JT3-3-5.5 x 25 + colour	SX3/9-L12-S16-6.0x29 + colour
Primary fixing for internal liner profile to cold rolled purlins	SH LS S16 5.5 x 25	JT3-3-5.5 x 25 S16	SX3/9-S16-6.0x29
Primary fixing for internal liner profile to hot rolled purlins	SH HS S16 5.5 x 40	JT3-12-5.5 x 40 S16	SX14/12-S16-5.5x40
Primary fixing for spacer bracket to cold rolled purlins	SH LS S16 5.5 x 28	JT3-3-5.5 x 35 S16	SX3/9-S16-6.0x29
Primary fixing for spacer bracket to hot rolled purlins	SH HS S16 5.5 x 40	JT3-12-5.5 x 40 S16	SX14/12-S16-5.5x40
External stitching screw for side-lap and/or metal flashing to external weathering profile	SH ST S16 5.5 x 22 PP+ colour	CF15-JT3-2-5.5 x 25 + colour	SL2-S-L12-S16-6.3x28 + colour
External rivet for side-lap and/or metal flashing to external weathering profile	RIV 0619 PP + colour	ALV 4.8 x 15 aluminium rivet (state colour required)	Polygrip-ASO-D-48100 + colour

When fixing to timber, fastener pullout values may limit the ability of the roof to resist wind uplift loads. If in doubt, consult the Technical Department. All fasteners can be sourced from SFS intec (T: +44 (0) 113 2085 500), PMJ-tec (T: +44 (0) 1451 822777), or EJOT UK Limited (T: +44 (0) 1977 687040).

Sealants and fillers

Vertical external profile

The end laps of the external weathering profile of the vertical Trisobuild® systems do not require sealant.

The side laps of the horizontal external weathering profile do not require sealant, but should be stitched at a maximum of 600mm centres.

For liner profile ends at eaves base of wall, white EPDM, MP or Superseal profile fillers should be located between the profile's internal profile and the internal cover flashing to provide continuity of air seal. These fillers should also be sealed top and bottom on a run of 9 x 3mm high grade butyl strip sealant.

The side laps of the vertical external weathering profile also do not require sealant, but should be stitched at a maximum of 500mm centres.

For external weathering black EPDM, MP or Superseal vented profile fillers should be located between the external profile and the cover flashing to provide continuity of weather seal and to prevent access by insects and small birds. These shaped fillers should be sealed at their base with a run of 9 x 3mm high grade butyl strip sealant.

All sealants can be sourced from either Premier Sealants (White strip), T: +44 (0) 1724 864100 EJOT UK Limited (Blue Strip), T: +44 (0) 1977 687040 SFS intec Ltd (Pink Strip), T: +44 (0) 113 208 5500.

Horizontal profile

The end laps of the external weathering profile of the horizontal Trisobuild® systems require two runs of gun-applied solvent-release sealant. Ensure the continuity and the effectiveness of the seal. The two lines of sealant must be placed between the sheets before fixing: one row 10mm from both the sheet ends at the top and bottom of the lap (ensure space is left for compression).

The liner profile should have both the side and end laps sealed. The end laps sealed with a 4mm diameter high grade butyl mastic (minimum 25 year guarantee). The side lap sealed with a 50 x 1mm high grade butyl mastic (minimum 25 year guarantee) positioned on top of joint.

All fillers can be sourced from either: Premier Sealants, T: +44 (0) 1724 864100 EJOT UK Limited, T: +44 (0) 1977 687040 Brett Martin, T: +44 (0) 24 7660 2022

Typical fastener layouts

More fasteners may need to be included to resist negative wind load forces. It is recommended that you speak to our Technical Department to discuss the specific loading and support structure on your project to ensure that sufficient restraint is being provided.

T: +44 (0) 1244 892199
E: technical.envelopeproducts@tatasteelconstruction.com

Fasteners, sealants and fillers

Horizontal external profile end lap

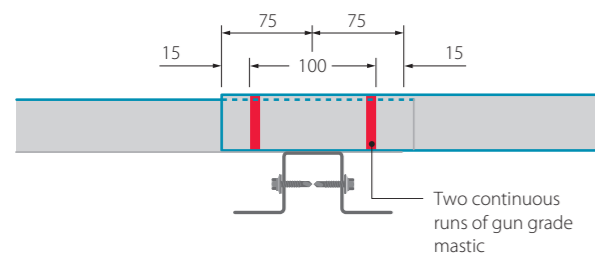

Vertical external profile and liner end lap

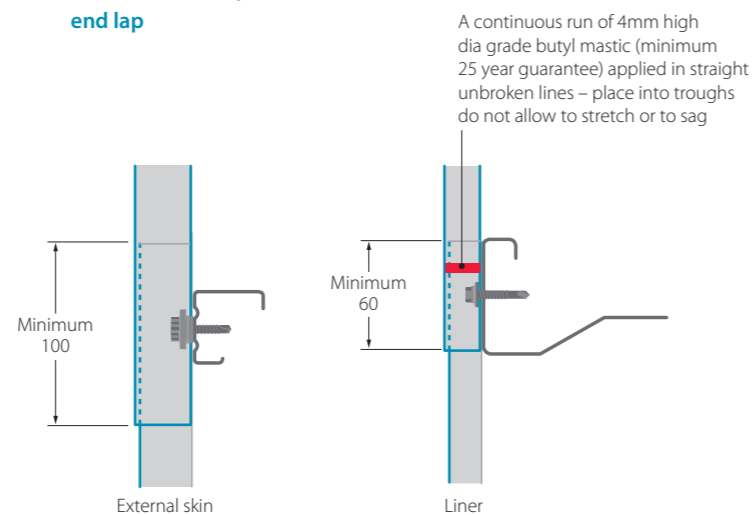

Horizontal external profile side lap

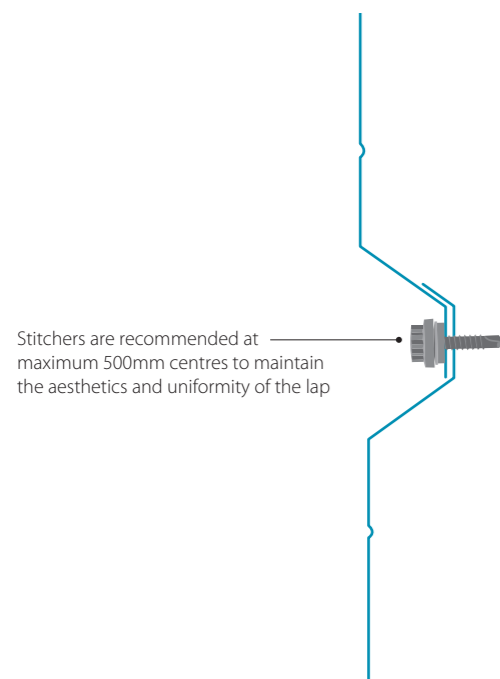

Vertical external profile side lap

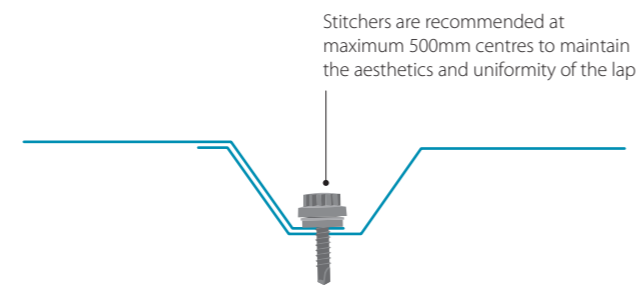

Internal profile side lap (same for both orientations)

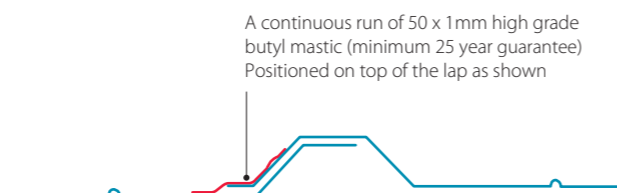

Performance benefits



Thermal performance

The Trisobuild® systems comply with the Building Regulations (Approved Document Part L2 – England, Wales & Technical Handbook 6 – Scotland). All quoted system U-values and construction 'psi' and f values have been computer modelled in accordance with EN ISO 10211 by trained and experienced technical engineers.



Fire safety

Our Trisobuild® fire wall (FW) systems are unique in offering specifications that will provide fire insulation resistance ratings of 15, 30, 60 and 120 minutes, together with 4 hours fire integrity resistance for all systems. The systems can be specified as vertical or horizontal, they can achieve their declared performance with standard installation methods and do not require internal stitching.

The external and internal surfaces of the Trisobuild® systems can be specified to meet the requirements within the Approved Document B (fire safety) Vol 2.

Trisobuild® systems have also achieved insurance based validation via the LPCB and is approved to standard LPS1181:1 to both levels EXT-A and EXT-B.



Acoustic performance

Trisobuild® systems can offer a wide variety of sound reduction and sound absorption solutions, using variations in liner and insulation specification. Many assemblies have been tested through independent acoustic laboratories some of which are shown on pages 14-17.

Tata Steel has further test data and the ability to offer predicted performance ratings.

Therefore if the needs of your project are not met within the systems shown in this brochure please provide details of your requirements to the Technical Department and our engineers will work with you to develop a solution to achieve the performance levels necessary.



Water penetration

All roof systems are capable of being laid at a 4 degree roof pitch (with the exception of the 13.5/3 profile which is limited to 10 degrees) when sealed to the recommendations within this brochure.



Air-tightness

The envelope cladding system and its junction details must be air-tight so that the air permeability of the building does not exceed 10m³/h/m² at an applied pressure of 50Pa, in accordance with the Building Regulations for England and Wales (Part L2) and Scotland (Technical Handbook Section 6 Energy).

The liner sheet generates the air-tightness within the Trisobuild® systems. High grade butyl mastic is used to seal the overlap joint between adjacent sheets and metal flashings and sealed fillers are used at end positions. For more information see pages 34 and 46. In laboratory tests, all liner panel junctions have shown air leakage of <math><0.30\text{m}^3/\text{h}/\text{m}^2</math>.

A practical expectation for a finished building, with effective sealing at all junctions would be 3-5m³/h/m². However enhanced detailing practises on large shed buildings can realise air leakage performance figures of less than 3m³/h/m².



Environmental credentials

As the first steel manufacturer to become an approved Environmental Product Declaration (EPD) programme operator, Tata Steel now have the ability to create product specific EPDs that comply with EN 15804 and ISO 14025 standards. Being able to supply product specific Type III externally verified EPDs, along with BES 6001 responsible sourcing certification, enables us to help our construction supply chains to accrue points, under building certification schemes such as LEED and BREEAM, on their building projects. In addition the level of transparency and reporting afforded by the operatorship allows optimum resource decisions to be made and demonstrates the sustainability of steel and our steel building products.

Trisobuild® systems are produced within the UK by Tata Steel's steel production, strip processing, galvanising, coating and profiling facilities. In addition the system's carbon footprint is further minimised by the manufacturing process being situated adjacent to the Colorcoat® pre-finished steel production facility.

All steel elements are truly recyclable, without any loss of quality. The insulation can be separated easily and if kept 'clean' can be recycled. In all cases, the positive value of the steel scrap more than offsets other disposal costs.



Hereford and Worcester Fire and Rescue Service, Kidderminster
 Client: Hereford & Worcester Fire and Rescue Service
 Main contractor: McPhillips (Wellington) Limited
 Cladding contractor: Kynaston Contract Services Limited
 Tata Steel products: Trisobuild® Pyramid 50/882 and Trisobuild® Pyramid 50/1000
 Colorcoat® product: Colorcoat Prisma®



www.tatasteelconstruction.com

Trademarks of Tata Steel UK Limited

Aquatite, Colorcoat, Colorcoat Connection, Colorcoat HPS200 Ultra, Colorcoat Prisma, Confidex, Galvalloy, Platinum, Repertoire, Scintilla, Trinsul and Trisobuild are registered trademarks of Tata Steel UK Limited.

While care has been taken to ensure that the information contained in this publication is accurate, neither Tata Steel, nor its subsidiaries, accept responsibility or liability for errors or for information which is found to be misleading.

Before using products or services supplied or manufactured by Tata Steel and its subsidiaries, customers should satisfy themselves as to their suitability.

Copyright 2020

Tata Steel UK Limited

Tata Steel

Shotton Works
Deeside
Flintshire
CH5 2NH

T: +44 (0) 1244 892199

E: technical.envelopeproducts@tatasteeleurope.com

W: www.tatasteelconstruction.com

Tata Steel UK Limited is registered in England under number 2280000, with registered office at 30 Millbank, London, SW1P 4WY

UK 0820